

S3000

Sürme Sistem
Sliding System

- **Sistem Kataloğu**
Teknik Özellikler
Profil Bilgisi
Sistem Detayları
Aksesuarlar
Montaj Talimatları
- **System Catalogue**
Technical Properties
Profile Data
System Details
Accessories
Fabrication Manual



Tarihçe

1984 yılında İstanbul Bayrampaşa'da alüminyum levha üretimine başladı. 1991 yılında ilk ekstrüzyon presini kurarak alüminyum profil üretimine başladı. 1994'te Hadımköy Tesislerine taşındı. 1995'te elektrostatik toz boya ünitesi ve dökümhane kuruldu. 1996'da ilk ihracatını gerçekleştirdi. 1997'de ikinci ekstrüzyon hattı devreye alındı. 1998'de ekstrüzyon hatları revize edildi, dökümhanenin kapasitesi artırıldı. 2002'de alu-line markasıyla, alüminyum yapı sistemleri üretilmeye başlandı. 2003-2008 yılları arasında 1.400 ve 2.000 tonluk pres hatları, eloksal ünitesi, CNC mekanik işlem makine parkuru devreye alındı, Lüleburgaz fabrikasının 12.500 m²'lik 1. etap inşaatı tamamlandı. 2011'de Lüleburgaz fabrikasının kuruluşu tamamlandı. 2012'de Aksan Alüminyum, gruba katıldı. 2013'te 65.000 m²'si kapalı alan olmak üzere toplam 220.000 m²'lik Lüleburgaz fabrikası tamamlanarak işletmeye alındı.

History

It started manufacturing aluminium sheet in İstanbul Bayrampaşa in 1984. It founded its first extrusion project in 1991 to produce aluminium profiles. In 1994, Hadımköy Plant started production. In 1995, electrostatic powder coating unit and foundry was opened. Burak implemented its first export in 1996. And the second extrusion line was commissioned in 1997. Extrusion lines were revised, and the foundry's capacity was increased in 1998. Production of architectural aluminium building systems was commenced with the brand name "alu-line" in 2002. 1,400 and 2,000 tons of extrusion lines, anodization unit CNC mechanical processing machinery were commissioned, and the 1st phase construction of 12,500 sqm Luleburgaz plant was completed between 2003 and 2008. The foundation of Luleburgaz plant was completed in 2011. Aksan Alüminyum joined the group in 2012. In 2013, total 220,000 sqm Luleburgaz plant with 65,000 sqm indoor space was completed and set into operation.

Üretim

Burak Alüminyum Endüstriyel:

Burak Alüminyum, standart alaşımlı ekstrüzyon profilin yanı sıra özel alaşımlı alüminyum profil üretimi de yapmaktadır. Nitelikli tasarım ihtiyacı olan otomotiv, havacılık sanayi, ısıtma-soğutma, mobilya reklam ve raylı sistemler gibi sektörlerle A'dan Z'ye hizmet vermenin yanı sıra güneş enerjisi, karavan, otomotiv, endüstriyel buzdolabı ve radyatör gibi alüminyumdan müteşkil yapı mamul ve bitmiş ürünler üretmektedir.

Burak Alüminyum Yapı sistemleri:

Burak, alu-line® markasıyla da mimari çözümler geliştirmektedir. Cephe giydirme, kapı ve pencere, sürme, ofis bölme sistemleri, küpeşte profilleri ve uyumlu aksesuarlarını üreten Burak, ayrıca alüminyum kompozit panelleri de BURAKBOND® ve alu-linebond® markalarıyla üretmekte ve tüm bu ürünleri 50 ülkeye ihraç etmektedir.

Product

Burak Alüminyum Industrial:

Burak Alüminyum also performs special alloy aluminium profile manufacture besides standard alloy extrusion profile. Besides serving industries such as automotive, aviation industry, heating-cooling, furniture promotions and rail systems which need qualified design from A to Z, it manufactures solar energy, semi-finished and finished products composed of aluminium such as caravan, automotive, industrial fridges, and radiators.

Burak Alüminyum Architectural Systems:

Burak develops architectural solutions with its alu-line® brand as well. Manufacturing facade, doors and windows, sliding, office partition systems, handrail profiles and their compatible accessories, Burak also manufactures aluminium composite panels via its BURAKBOND® and alu-linebond® brands and exports these products to 50 countries.

S3000 / SÜRME - SLIDING

S3000

SÜRME SİSTEM
SLIDING SYSTEM

1

HAFİF SÜRME SİSTEM
LIGHT SLIDING DOOR SYSTEM



TEKNİK ÖZELLİKLER
TECHNICAL PROPERTIES

KASA DERİNLİĞİ / FRAME DEPTH :	89,5 mm
KANAT DERİNLİĞİ / VENT DEPTH :	37,5 mm
PROFİL ET KALINLIĞI / PROFILE WALL THICKNESS :	1,2 - 1,5 mm
MAX. CAM KALINLIĞI / MAX. GLASS THICKNESS :	24 mm
ISI BARIYERLERİ / INSULATION BARS :	10 mm
ISI YALITIM DEĞERİ (Uf) / THERMAL INSULATION VALUE (Uf) :	4,44 W/m²K

KULLANIM SEÇENEKLERİ
APPLICATION ALTERNATIVES

	PENCERE WINDOW	KAPI DOOR
NORMAL SÜRME / SLIDING :	●	●
SABİT KASA / FIXED FRAME :		
ÜÇ RAYLI KASA / THREE RAILED FRAME :		
SİNEKLİK UYUMU / APPLICABLE TO INSECT SCREEN :	●	●

S3000 / SÜRME - SLIDING

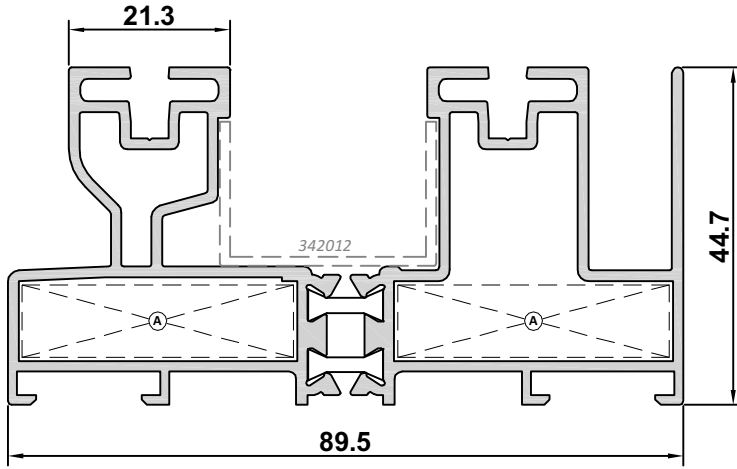

YES-23		
KÖŞE TAKOZLARI CORNER CLEATS		
111193: A (Pres / Press)		
STATİK DEĞERLER STATIC VALUES		
Jx (cm ⁴)	Jy (cm ⁴)	y x
13,75	51,16	
AĞIRLIK / WEIGHT		
1,916 kg/m		

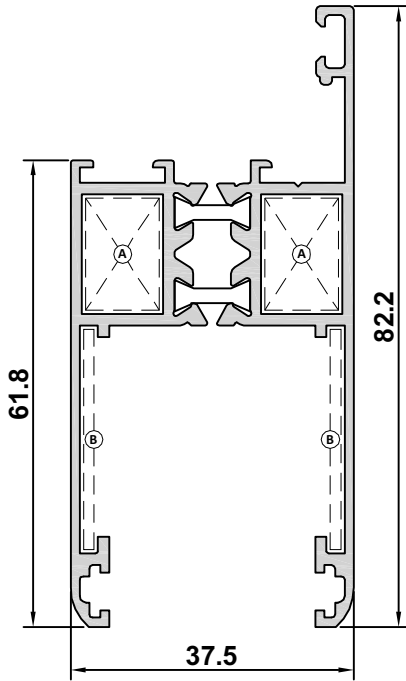

YES-11		
KÖŞE BAĞLANTILARI CORNER CONNECTIONS		
111106: A (Pres / Press)		
332018: B		
STATİK DEĞERLER STATIC VALUES		
Jx (cm ⁴)	Jy (cm ⁴)	y x
17,60	8,28	
AĞIRLIK / WEIGHT		
1,211 kg/m		

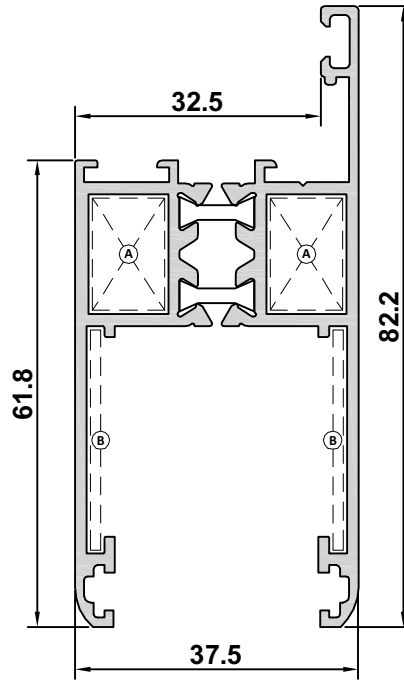

YES-11-16		
KÖŞE BAĞLANTILARI CORNER CONNECTIONS		
111106: A (Pres / Press)		
332018: B		
STATİK DEĞERLER STATIC VALUES		
Jx (cm ⁴)	Jy (cm ⁴)	y x
18,40	8,82	
AĞIRLIK / WEIGHT		
1,290 kg/m		

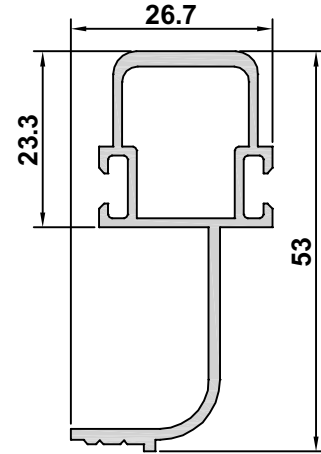

EHS-51		
STATİK DEĞERLER STATIC VALUES		
Jx (cm ⁴)	Jy (cm ⁴)	y x
6,04	0,97	
AĞIRLIK / WEIGHT		
0,547 kg/m		

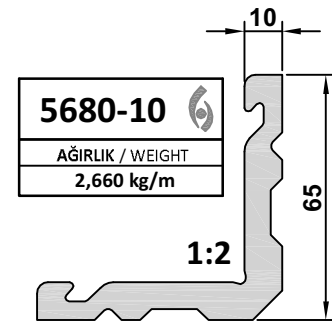
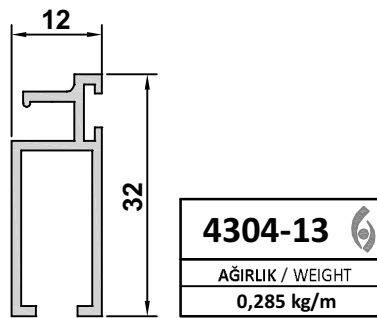
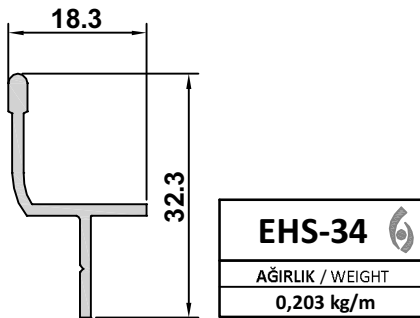
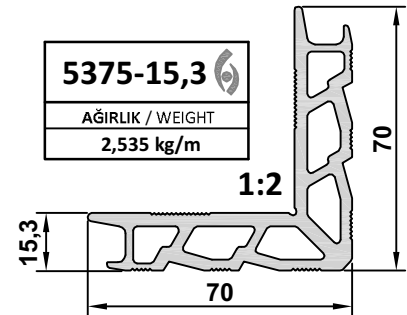
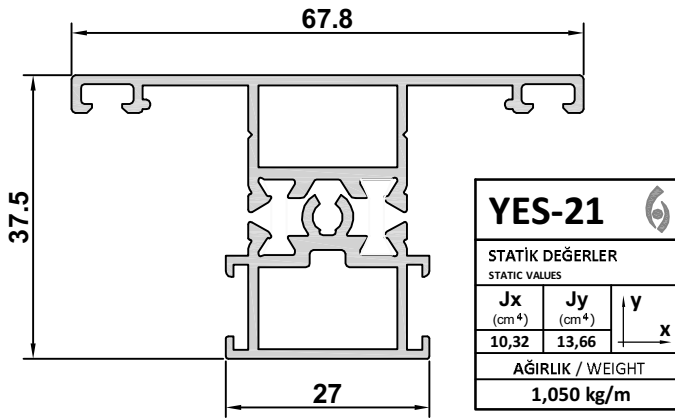
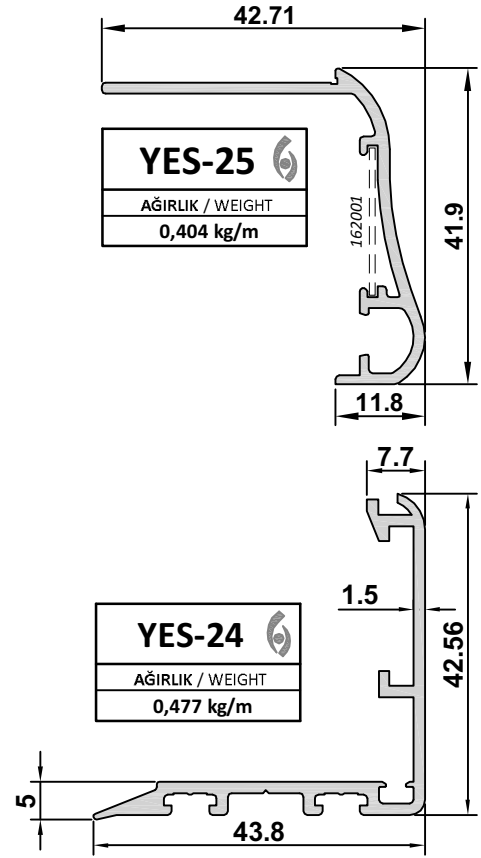
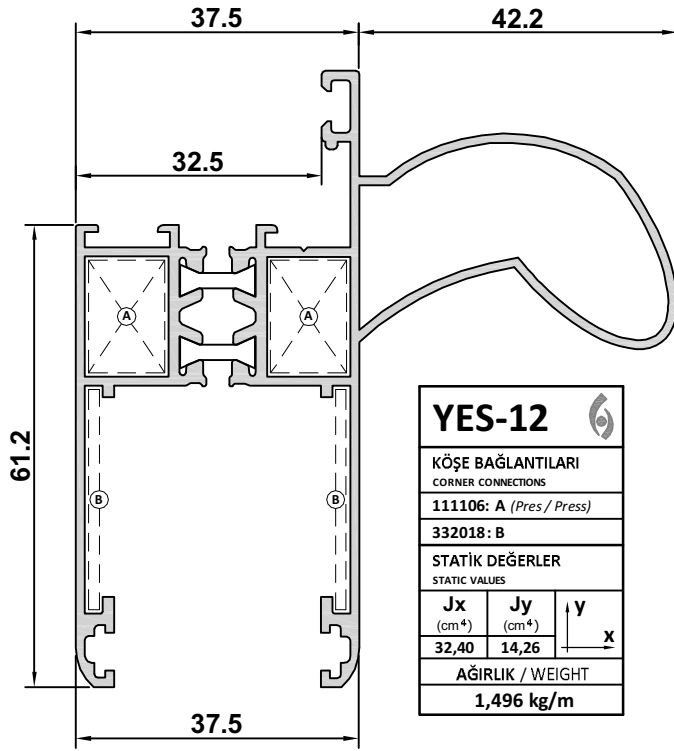

S3000 / SÜRME - SLIDING

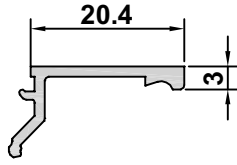

EHS-40
AĞIRLIK / WEIGHT
0,144 kg/m

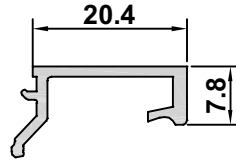

EHS-42
AĞIRLIK / WEIGHT
0,170 kg/m

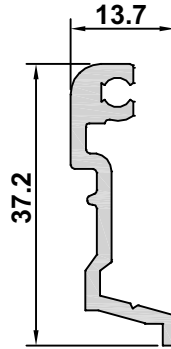

EHS-80
AĞIRLIK / WEIGHT
0,344 kg/m

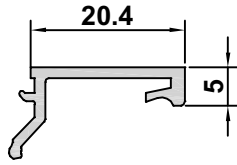

EHS-41
AĞIRLIK / WEIGHT
0,160 kg/m

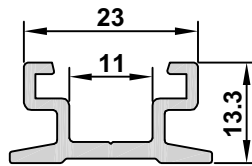





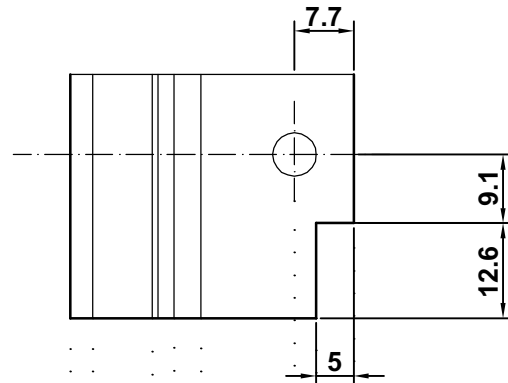



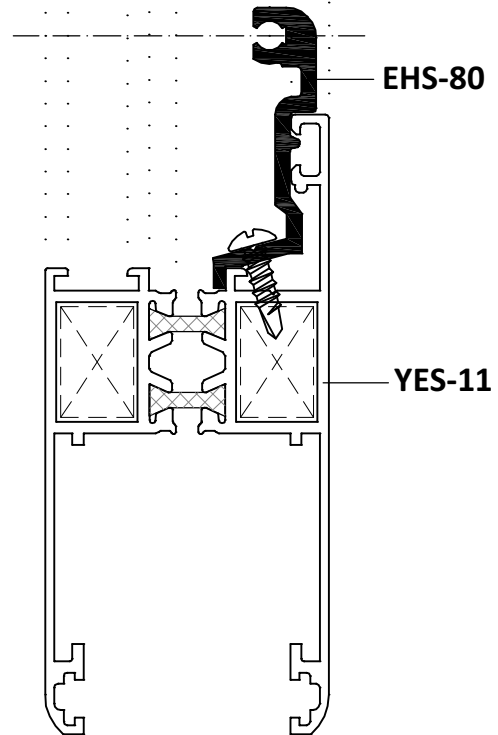
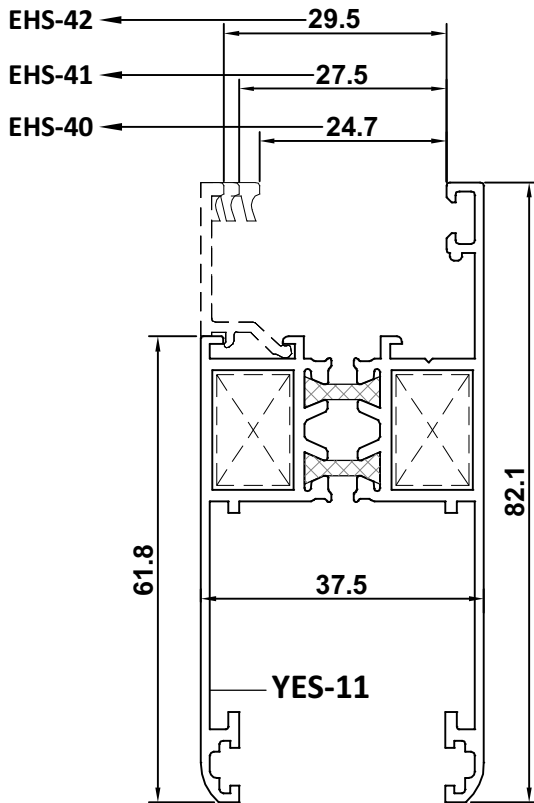



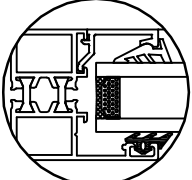

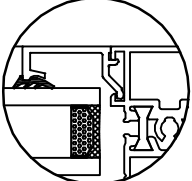

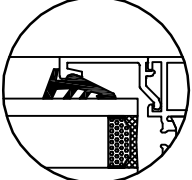
20302
AĞIRLIK / WEIGHT
0,301 kg/m

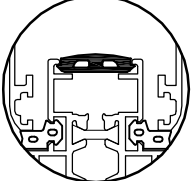
ORTA KAYIT BAĞLANTI DETAYI
TRANSOM CONNECTION DETAIL

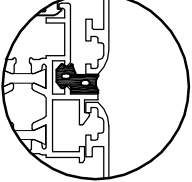

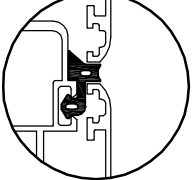

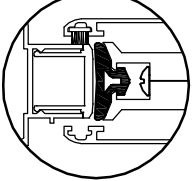
CAM ÇITASI BOŞLUKLARI
SPACES FOR THE GLAZING BEADS

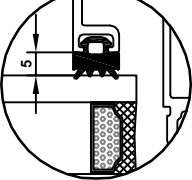

EPDM FİTİLLER / EPDM GASKETS		
ÇİZİM / DRAWING	AKSESUAR KODU VE ÜRÜN BİLGİLERİ / ACCESSORY CODE AND PRODUCT DESCRIPTION	TAKILMA BÖLGESİ / APPLICATION AREA
	212028 DIŞ CAM FİTİLİ / OUTER GLAZING GASKET BİRİM AĞIRLIK / UNIT WEIGHT : 61 g/m KOLİ MİKTARI / PACKAGE QUANTITY : 245 m	
	212029 İÇ BİNİ FİTİLİ / INNER STEP GASKET mm BİRİM AĞIRLIK / UNIT WEIGHT : 47 g/m KOLİ MİKTARI / PACKAGE QUANTITY : 310 m	
	212035 İÇ BİNİ FİTİLİ / INNER STEP GASKET BİRİM AĞIRLIK / UNIT WEIGHT : 70 g/m KOLİ MİKTARI / PACKAGE QUANTITY : 210 m	
	212140 ORTA ADAPTÖR FİTİLİ / ADAPTER STEP GASKET BİRİM AĞIRLIK / UNIT WEIGHT : 65 g/m KOLİ MİKTARI / PACKAGE QUANTITY : 230 m	
	212141 ORTA ADAPTÖR FİTİLİ / ADAPTER GASKET BİRİM AĞIRLIK / UNIT WEIGHT : 50 g/m KOLİ MİKTARI / PACKAGE QUANTITY : 300 m	
	212142 ORTA ADAPTÖR FİTİLİ / ADAPTER GASKET BİRİM AĞIRLIK / UNIT WEIGHT : 65 g/m KOLİ MİKTARI / PACKAGE QUANTITY : 230 m	
	212073 STOPER FİTİLİ / ISTOPPER GASKET BİRİM AĞIRLIK / UNIT WEIGHT : 150 g/m KOLİ MİKTARI / PACKAGE QUANTITY : 100 m	
	212003 İÇ BİNİ FİTİLİ 5 mm / INNER STEP GASKET 5 mm BİRİM AĞIRLIK / UNIT WEIGHT : 72 g/m KOLİ MİKTARI / PACKAGE QUANTITY : 220 m	

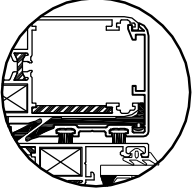
S3000 / SÜRME - SLIDING

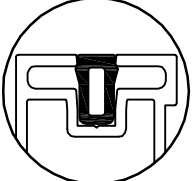
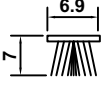
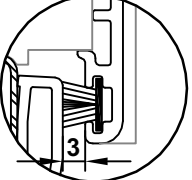
EPDM FİTİLLER / EPDM GASKETS		
ÇİZİM / DRAWING	AKSESUAR KODU VE ÜRÜN BİLGİLERİ / ACCESSORY CODE AND PRODUCT DESCRIPTION	TAKILMA BÖLGESİ / APPLICATION AREA
	212143 KENET FİTİLİ / CLAMP GASKET BİRİM AĞIRLIK / UNIT WEIGHT : 90 g/m KOLİ MİKTARI / PACKAGE QUANTITY : 170 m	
	212144 KASA FİTİLİ / FRAME GASKET BİRİM AĞIRLIK / UNIT WEIGHT : 40 g/m KOLİ MİKTARI / PACKAGE QUANTITY : 375 m	
	232021 PERDELİ FIRÇA FİTİL 69-700 / WEATHER STRIP BRUSH KOLİ MİKTARI / PACKAGE QUANTITY : 450 m	

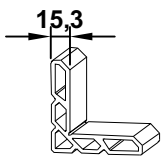
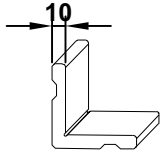
KÖŞE TAKOZLARI / CORNER CLEATS		
ÇİZİM / DRAWING	AKSESUAR KODU VE ÜRÜN BİLGİLERİ / ACCESSORY CODE AND PRODUCT DESCRIPTION	KESİM ÖLÇÜSÜ / CUTTING DIMENSION
	111106 PROFİL NUMARASI / PROFILE NUMBER : 5375-15,3 PROFİL AĞIRLIĞI / PROFILE WEIGHT : 2,903 kg/m	10 mm
	111193 PROFİL NUMARASI / PROFILE NUMBER : 5680-10 PROFİL AĞIRLIĞI / PROFILE WEIGHT : 2,660 kg/m	36,5 mm

MERKEZİ KANAL PARÇASI
CENTRAL INSULATION BAR

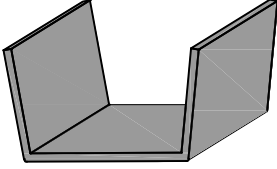

342012

PVC KÖŞE ÇAVUŞU
PVC CORNER ALIGNMENT

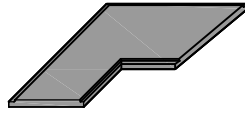

332018

ÇELİK RAY
STEEL RAIL

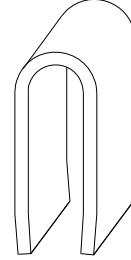

332036

RULMAN
PULLEY



552001

KENET KERTME KAPAĞI
CLAMP PLUG



332031

STOPER
STOPPER

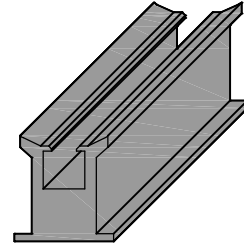

332020

SABİT KANAT BESLEME TAKOZU
FIXED SASH SUPPORT PIECE

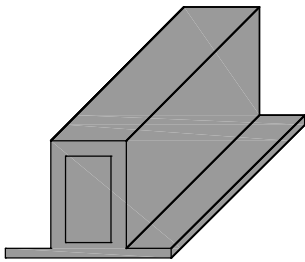

332027

PİM VE KARŞILIK
PIN AND STRIKER

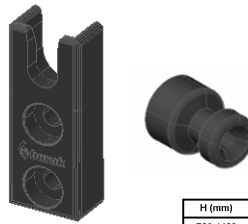

H (mm)	ADET
700-1400	2
1401-2200	4
2201-3000	6

732013

KOL BAĞLANTISI
CREMONE CONNECTION



642003

S3000 / SÜRME - SLIDING

TABLO 1: KANAT ÖLÇÜLERİNE GÖRE KİLİTLEME SETLERİ
TABLE 1: LOCKING KITS ACCORDING TO SASH DIMENSIONS

KOD CODE	ÜRÜN TANIMI PRODUCT DESCRIPTION	H:700-1400	H:1400-2200	H:2200-3000
613011	ÇİFT MAÇALI KOL TWO-WAY CREMONE	1	1	1
642003	ÇİFT MAÇALI KOL BAĞLANTISI TWO-WAY CREMONE CONNECTION	2	2	2
732013	PİM VE KARŞILIK PIN AND STRIKER	2	4	6

