

ST 80

Detay Çizimleri
Section Drawings

İçe Açılır Kapı
Inward Opening Door

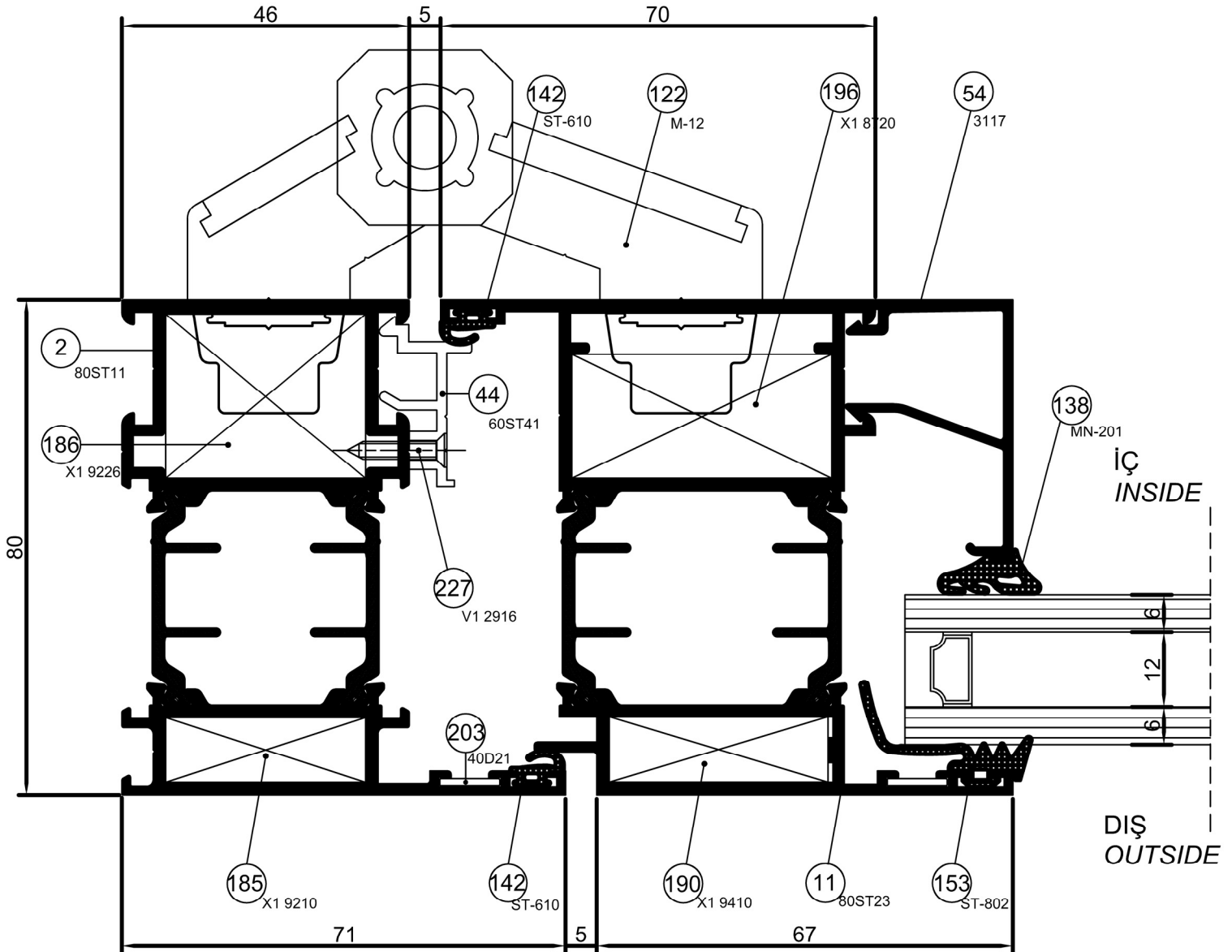
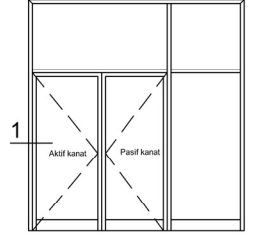

DETAIL ① DETAYI

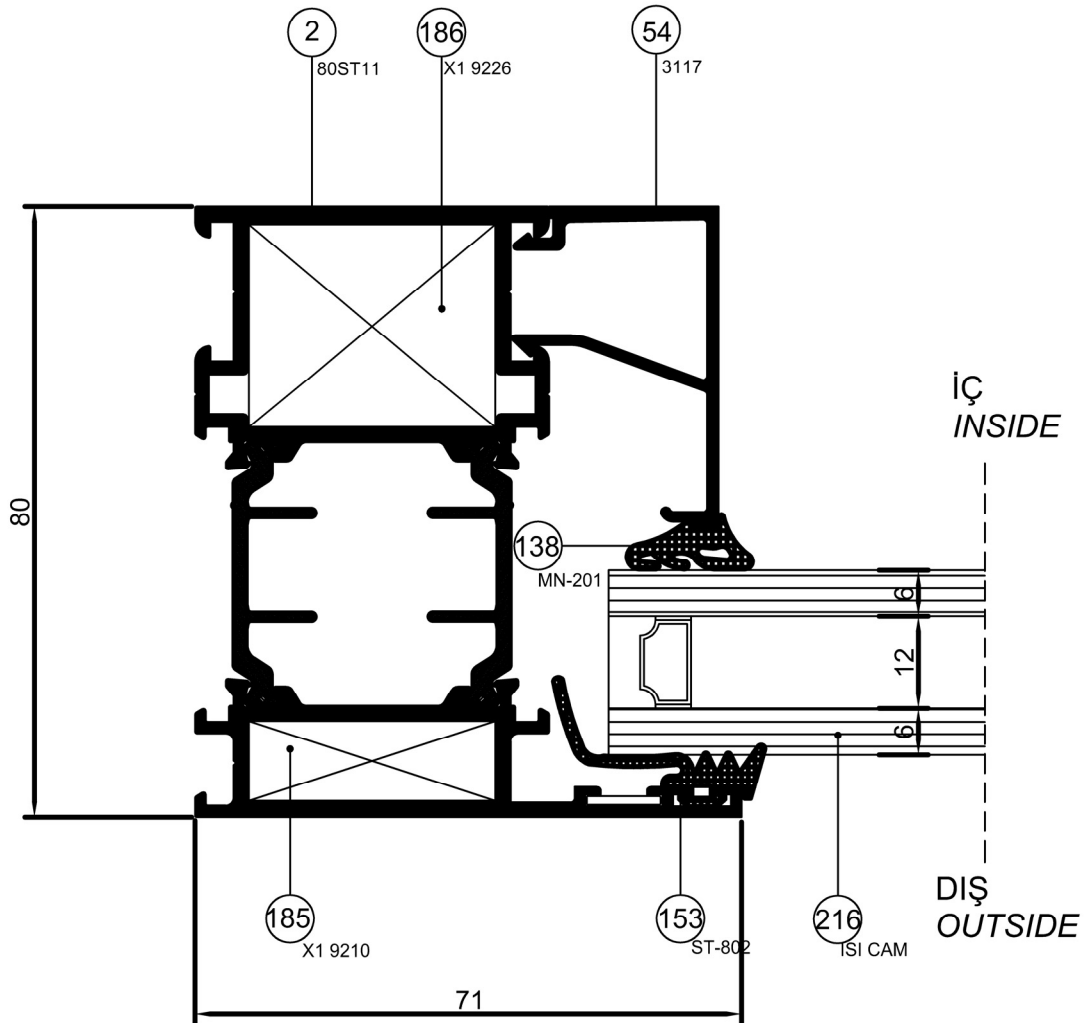
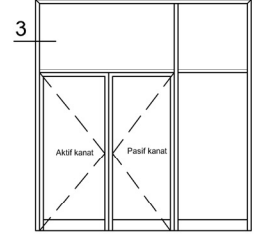
Detay Çizimleri
Section Drawingsİçe Açılır Kapı
Inward Opening Door

Ölçek / Scale : 1/1

DETAIL ③ DETAYI

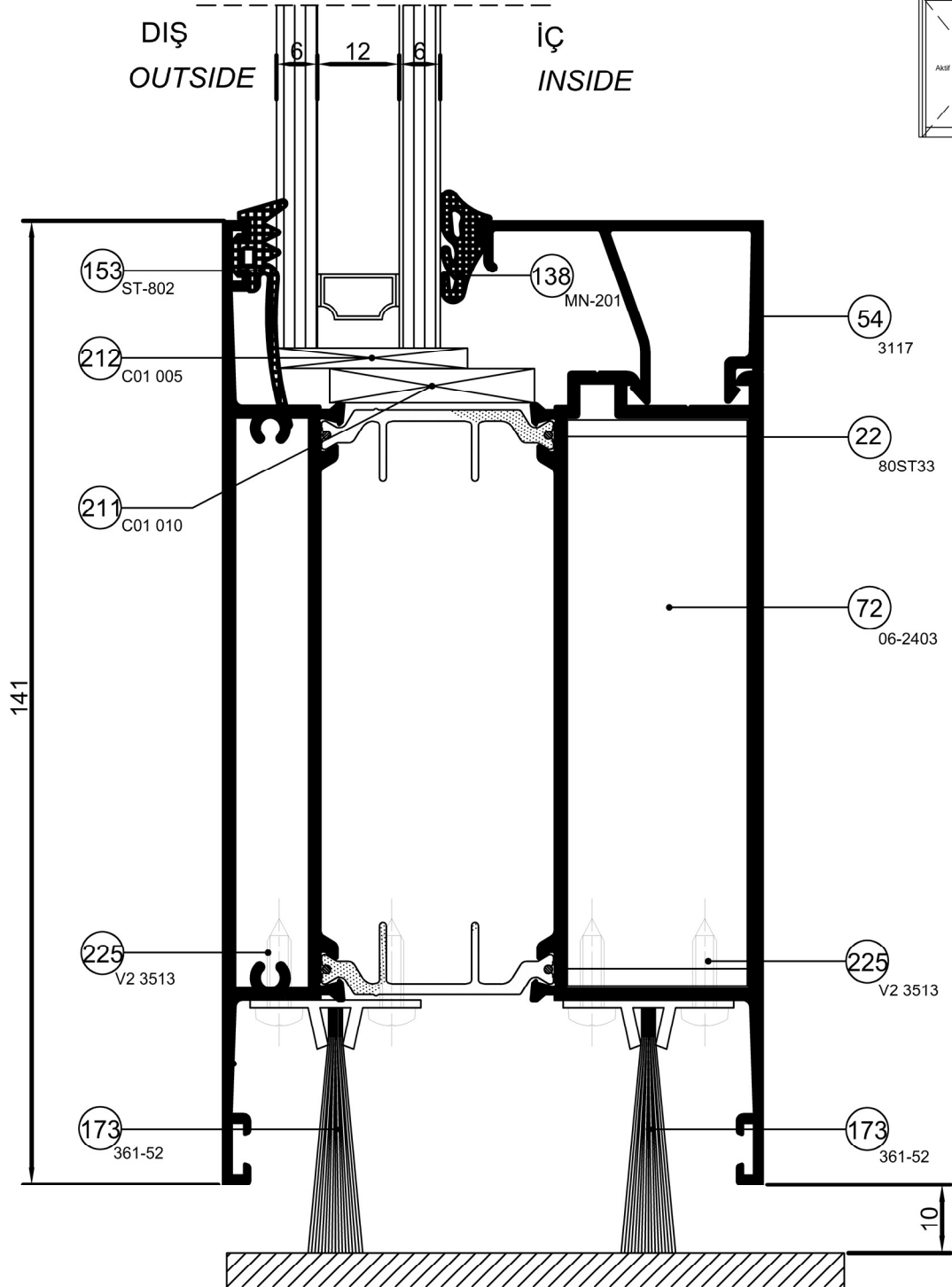
Detay Çizimleri
Section Drawingsİçe Açılır Kapı
Inward Opening Door

DETAIL ④ DETAYI

Ölçek / Scale : 1/1

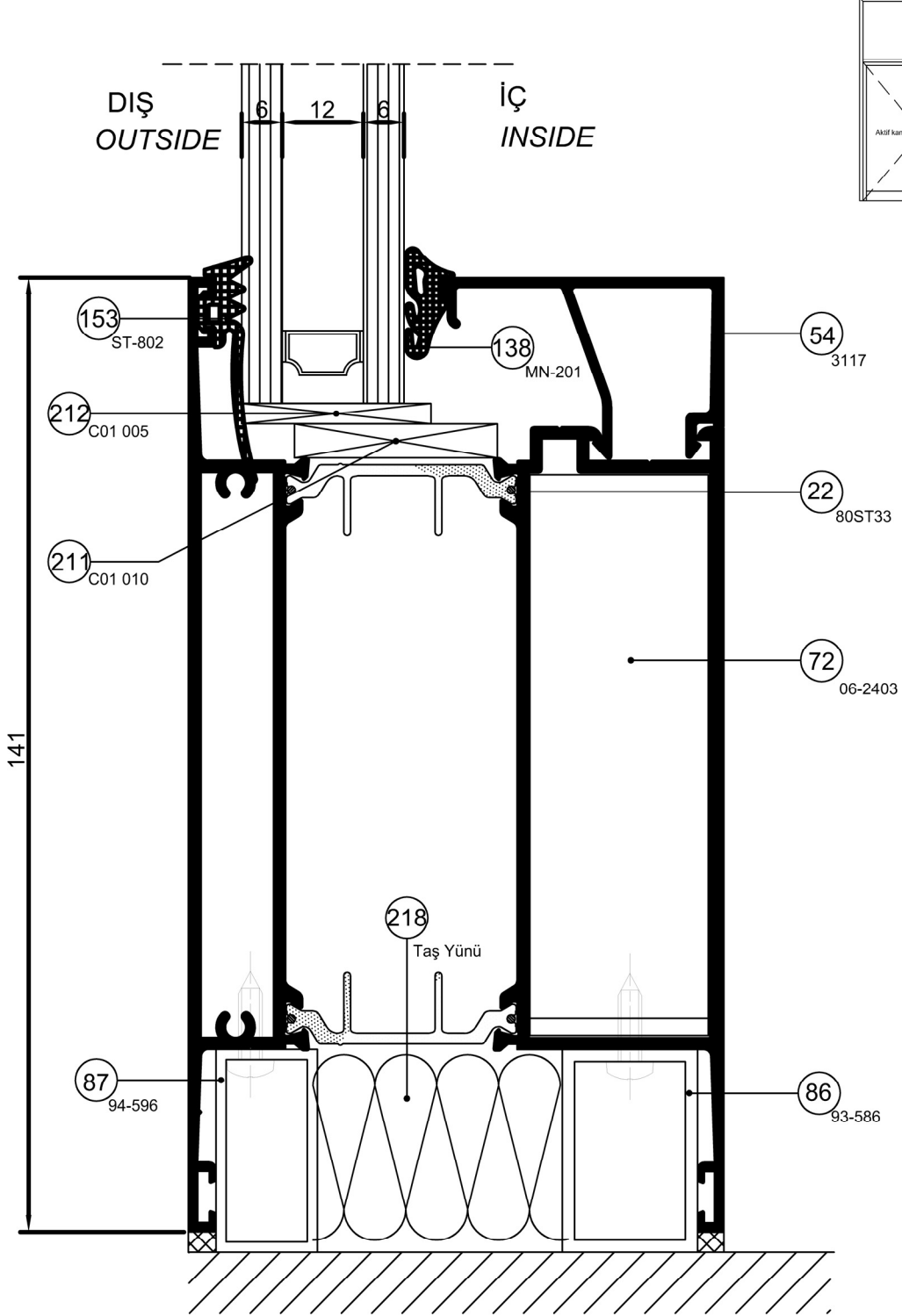
Detay Çizimleri
Section Drawingsİçe Açılır Kapı
Inward Opening Door

DETAY 5 DETAYI

Ölçek / Scale : 1/1

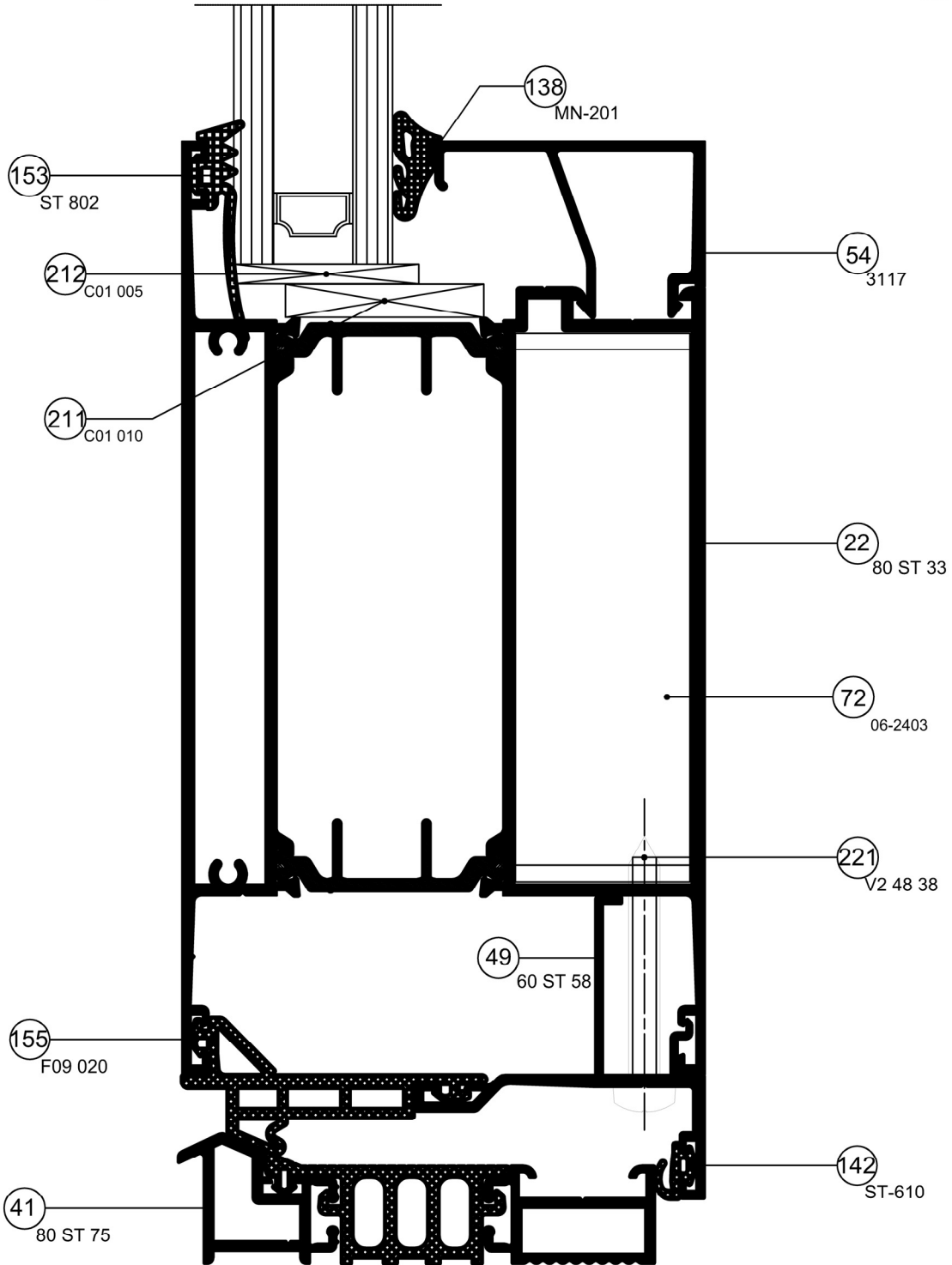
Detay Çizimleri
Section Drawingsİçe Açılır Kapı
Inward Opening Door

DETAIL ④ DETAYI

Ölçek / Scale : 1/1

Detay Çizimleri
Section Drawings

İçe Açılır Kapı
Inward Opening Door

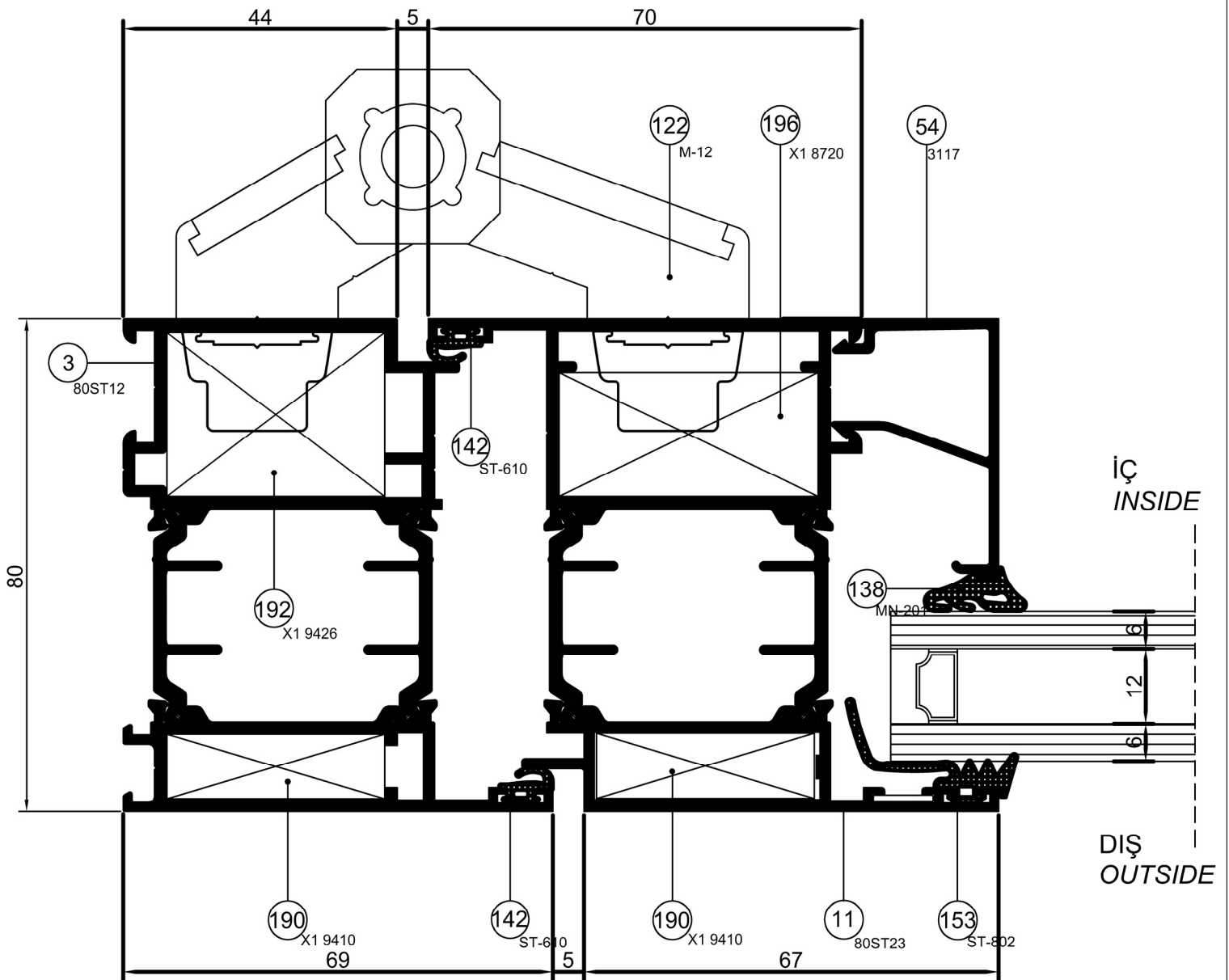
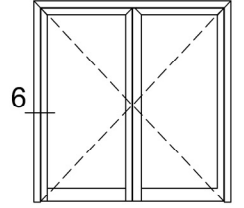

DETAIL ⑥ DETAYI

Ölçek / Scale : 1/1

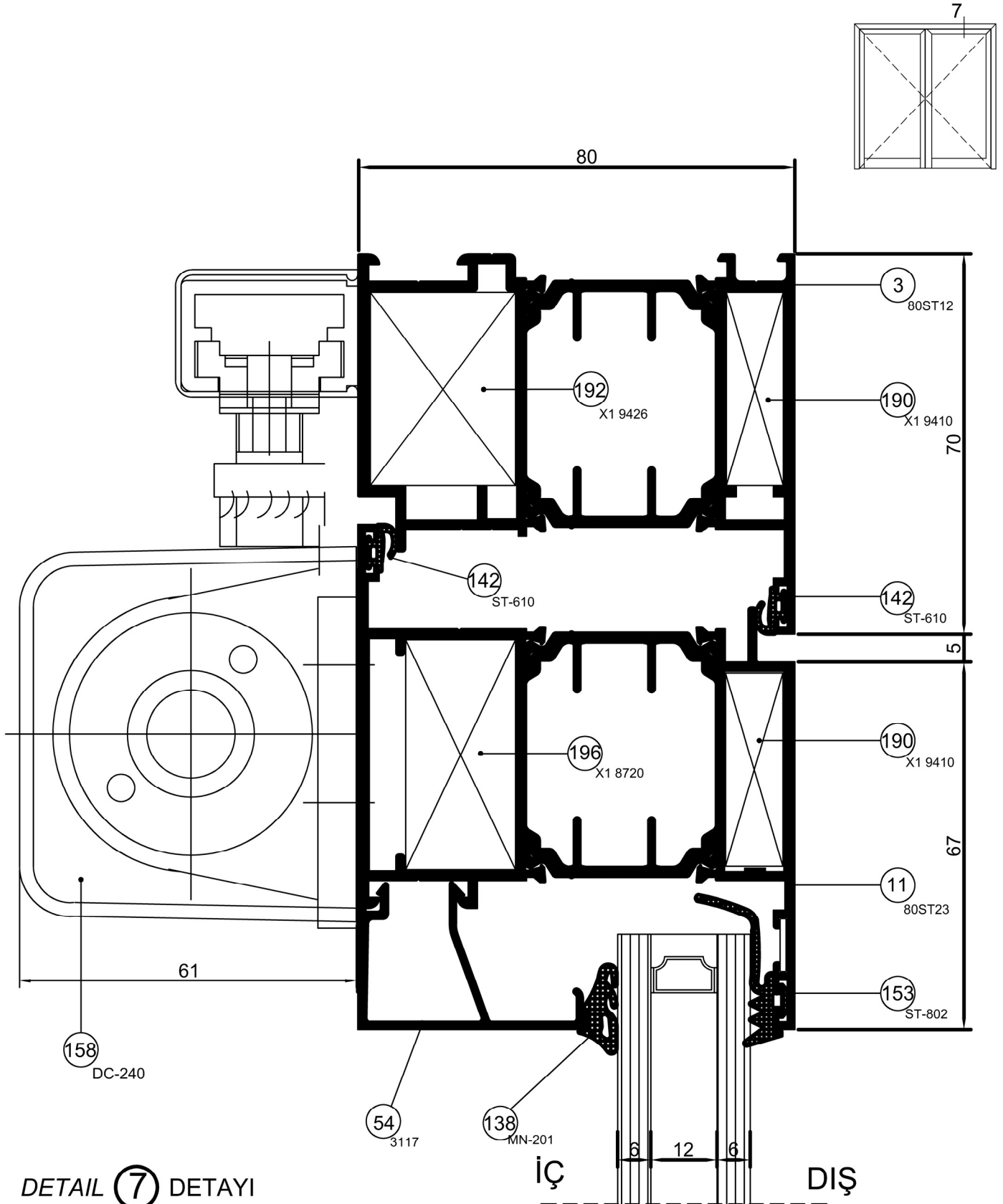
Detay Çizimleri
Section Drawingsİçe Açılır Kapı
Inward Opening Door

Ölçek / Scale : 1/1

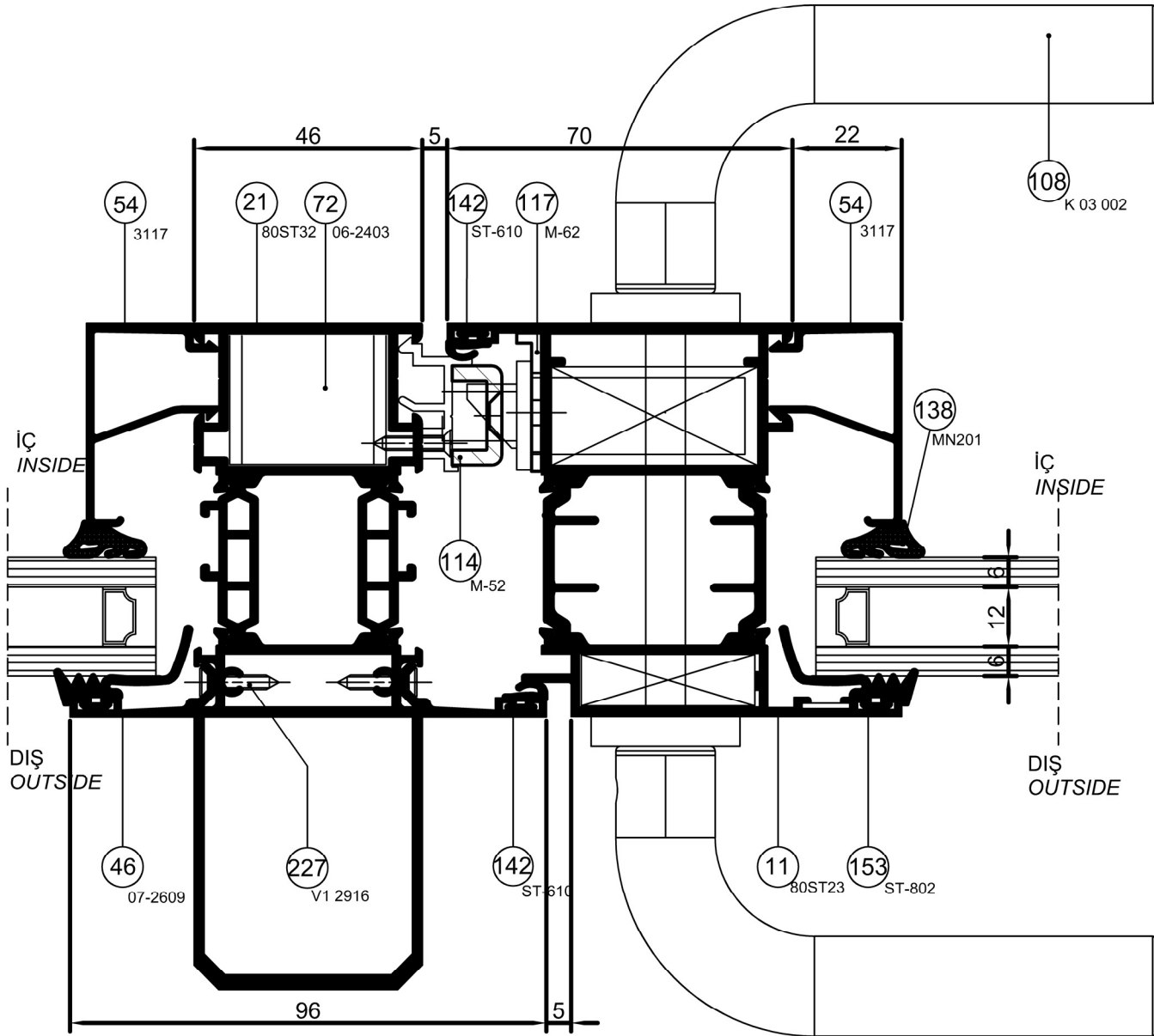
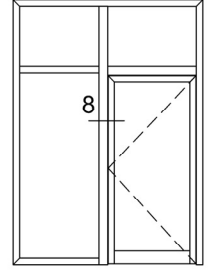
Detay Çizimleri
Section Drawingsİçe Açılır Kapı
Inward Opening Door

DETAIL (8) DETAYI

Ölçek / Scale : 3/4

Ocak 2012

Detay Çizimleri
Section Drawings

İçe Açılır Kapı
Inward Opening Door

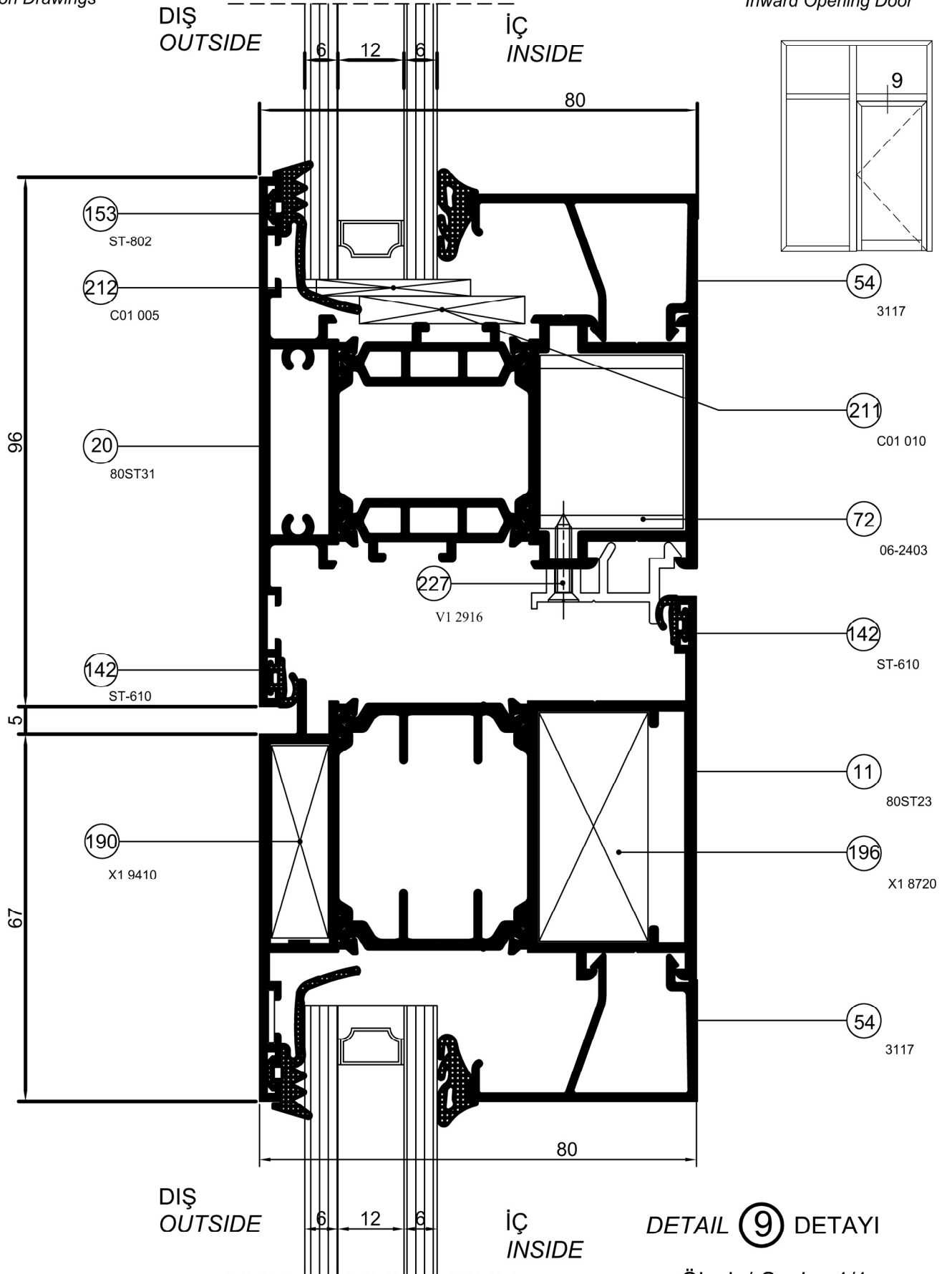

Detay Çizimleri
Section Drawings

İçe Açılır Kapı
Inward Opening Door

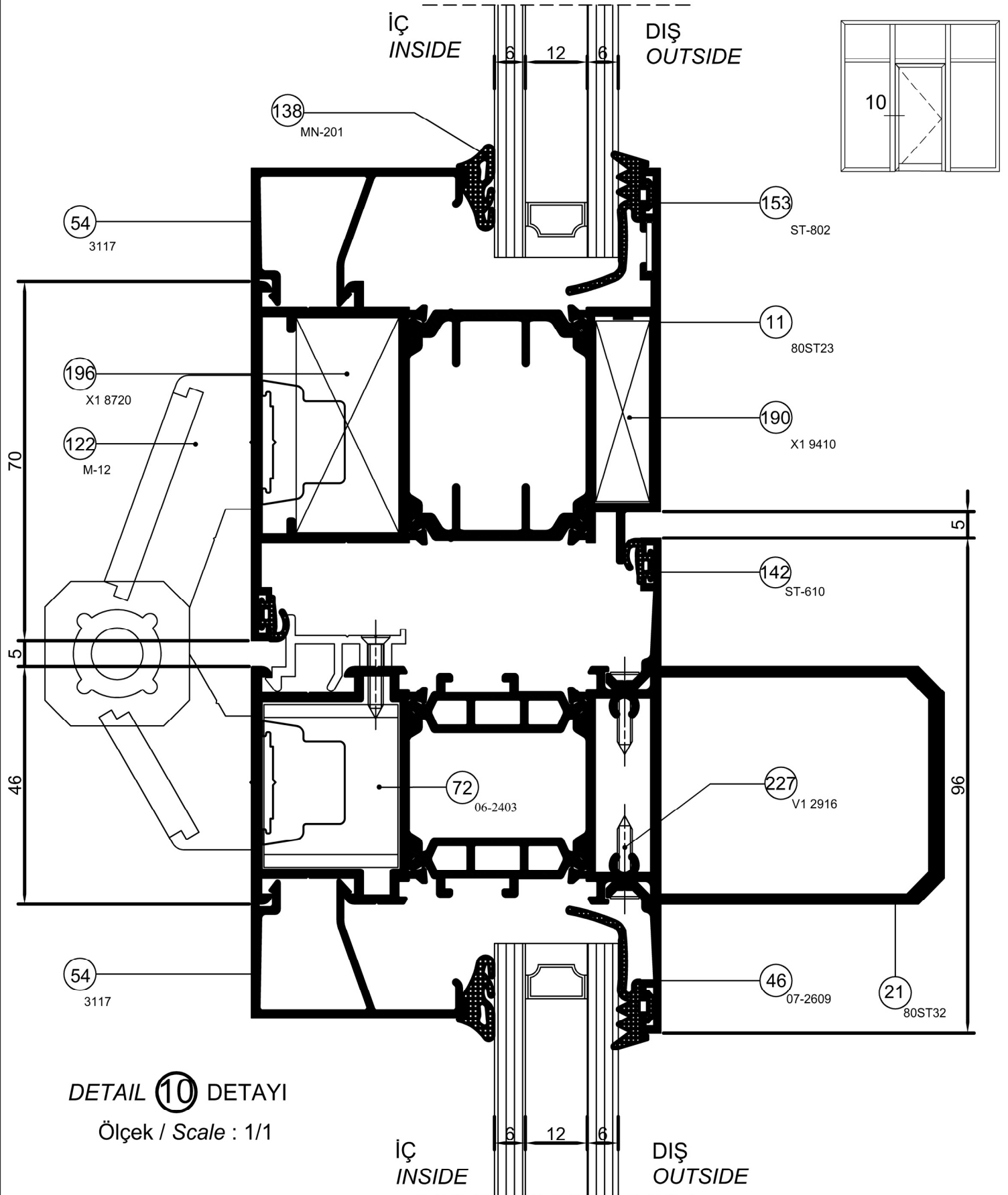

DETAIL 10 DETAYI

Ölçek / Scale : 1/1