

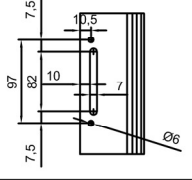

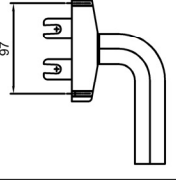

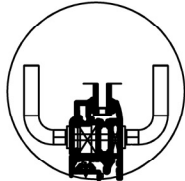

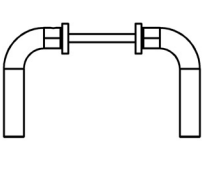

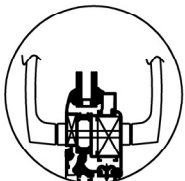
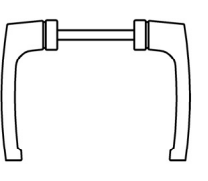



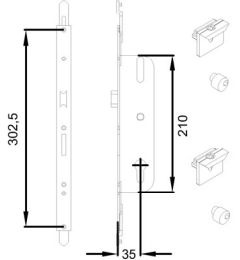
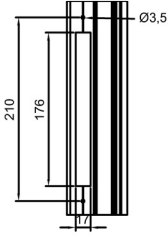
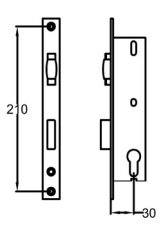
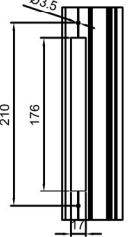
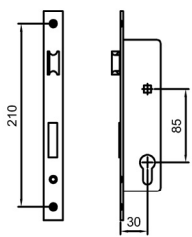
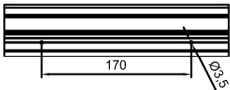
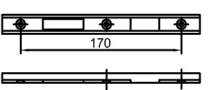
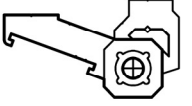
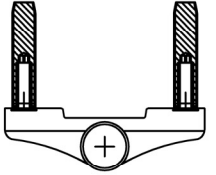
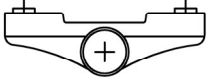
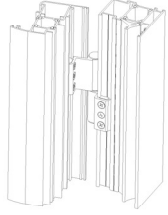
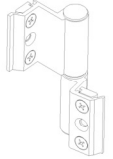
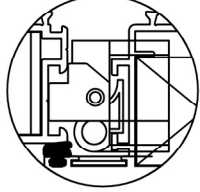
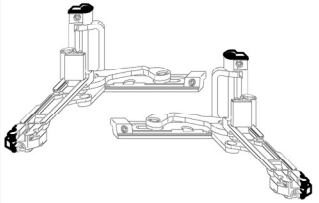
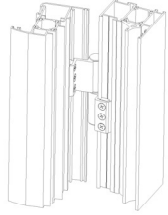
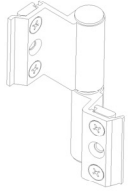
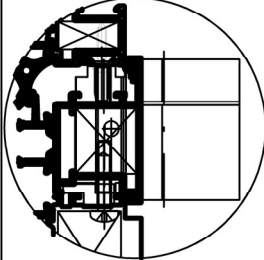
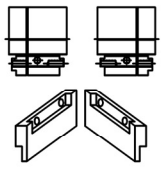
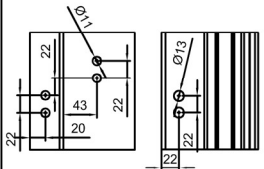
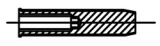

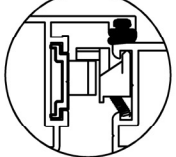
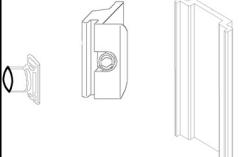

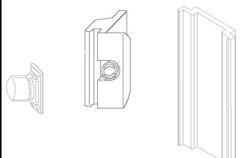

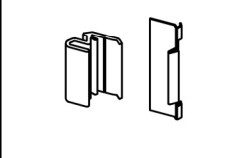

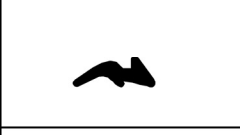

No	Aksesuar Adı Accessories Name	Kodu Code	Kullanıldığı Profiller Profiles	İmalat Ölçüleri Dimensions for Assembling	Aksesuar Accessories
101	Dilli Kol (İçe açılır pencere) Handle (Inward opening window) 1 Adet / Paket 1 Piece / Pocket Renk : Colour : (Renk siparişte belirtilmelidir)	40 D 24	80 ST 25 80 ST 63 Her pencere için 1 adet 1 piece for window		
102	Dilli Kol (Dışa açılır balkon kapısı) Handle (Outward opening balcony door) 1 Adet / Paket 1 Piece / Pocket	40 D 14	80 ST 26 Her balkon kapısı için 1 adet 1 piece for balcony door		
103	Dışa Açılır Kol (Anahtarlı Sağ) Right handle with key 1 Adet / Paket 1 Piece / Pocket Renk : Mil : Z 06 003 Colour : Rod : Z 06 003 (Renk siparişte belirtilmelidir)	K 02 005	80ST61 Her pencere için 1 adet 1 piece for window		
104	Dışa Açılır Kol (Anahtarlı Sol) Left handle with key 1 Adet / Paket 1 Piece / Pocket Renk : Mil : Z 06 003 Colour : Rod : Z 06 003 (Renk siparişte belirtilmelidir)	K 02 006	80ST61 Her pencere için 1 adet 1 piece for window		
105	Dışa Açılır Kol (Anahtarsız Sağ) Right handle without key 1 Adet / Paket 1 Piece / Pocket Renk : Mil : Z 06 003 Colour : Rod : Z 06 003 (Renk siparişte belirtilmelidir)	K 02 011	80ST61 Her pencere için 1 adet 1 piece for window		
106	Dışa Açılır Kol (Anahtarsız Sol) Right handle without key 1 Adet / Paket 1 Piece / Pocket Renk : Mil : Z 06 003 Colour : Rod : Z 06 003 (Renk siparişte belirtilmelidir)	K 02 012	80ST61 Her pencere için 1 adet 1 piece for window		

No	Aksesuar Adı Accessories Name	Kodu Code	Kullanıldığı Profiller Profiles	İmalat Ölçüleri Dimensions for Assembling	Aksesuar Accessories
107	Çift Dilli Kol (Dışa açılır Pivot) Handle (Outward opening Pivot) 1 Adet / Paket 1 Piece / Pocket	K06 003	80ST25		
108	Basma Kol / Handle 1 Adet / Paket 1 Piece / Pocket (Renk siparişte belirtilmelidir)	K03 002	80ST23		
109	Basma Kol / Handle 1 Adet / Paket 1 Piece / Pocket (Renk siparişte belirtilmelidir)	K03 004	80ST22		
110	Maçalı Kol (İçe Açılır daire kapısı) Handle (Inward opening door) 1 Adet / Paket 1 Piece / Pocket (Renk siparişte belirtilmelidir)	K02 016	80ST25 Her pencere için 1 adet 1 piece for window		
111	Kilit Lock 1 Adet / Paket 1 Piece / Pocket 2 adet karşılık, 2 adet pim.	L04 007	80ST22 Her kapı için 1 adet 1 piece for door		
112	Makaralı Kilit Lock 1 Adet / Paket 1 Piece / Pocket	40 D 7006	80ST23 Her kapı için 1 adet 1 piece for door		
113	Kilit Lock 1 Adet / Paket 1 Piece / Pocket	40 D 7002	80ST23 Her kapı için 1 adet 1 piece for door		
114	Dilli Kilit Karşılığı (kapı) Plate 1 Adet / Paket 1 Piece / Pocket	M52	80ST12 Her kapı için 1 adet 1 piece for door		

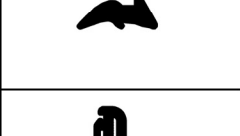
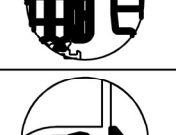
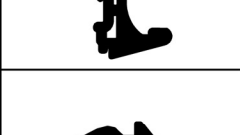
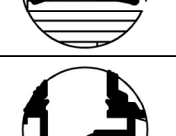

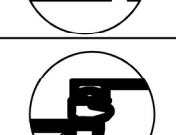









No	Aksesuar Adı Accessories Name	Kodu Code	Kullanıldığı Profiller Profiles	İmalat Ölçüleri Dimensions	Aksesuar Accessories
115	Dilli Kilit Karşılığı (kapı) Plate	L02 006	80 ST 11 80 ST 14		
116	Makaralı Kilit Karşılığı (balkon kapısı) Plate 1 Adet / Piece	M53	Her kapı için 1 adet 1 piece for door	-----	
117	Kilit Altı Subframe for Lock 1 Adet / Paket 1 Piece / Pocket	M62	80ST23 80ST23 Her kapı için 1 adet 1 piece for door		
118	Dışa Açılır Balkon Kapısı İspanyolet Çubuğu Sürücüsü Outward Opening-Balcony Doors Driver	412-808	80ST26 Her kol için 1 takım 1 kit for handle		
119	İspanyolet Mekanizması Espagnolette Mechanism 1 Adet / Piece	K 50 01	80ST61 Her pencere için 1 adet 1 piece for window		
120	Menteşe (dışa açılır) Hinge 4 Adet / Paket 4 Piece / Pocket	M10	80ST24-80ST32 Her kapı için 2 adet 2 piece for door		
121	Menteşe (dışa açılır) ve Vidalı Ankraj Hinge (outward opening) and Screw Anchor 4 Adet Mentşe + 8 Vidalı Ankraj / Paket 4 Piece Hinges + 8 Screw Anchors / Pocket	M101	80ST24-80ST32 Her kapı için 2 adet 2 piece for door		
122	Menteşe (içe açılır) Hinge 4 Adet / Paket 4 Piece / Pocket	M12	80ST12-80ST23 Her kapı için 2 adet 2 piece for door		
123	Menteşe (dışa açılır) Hinge 4 Adet / Paket 4 Piece / Pocket	M12	80ST13-80ST24 Her kapı için 2 adet 2 piece for door		
124	Menteşe (dışa açılır) & vidalı ankraj Hinge & Screw Anchor 4 Adet Mentşe + 16 Vidalı Ankraj / Paket 4 Piece Hinges + 16 Screw Anchors / Pocket	M121	80ST13-80ST24 Her kapı için 2 adet 2 piece for door		



No	Aksesuar Adı Accessory Name	Kodu Code	Kullanıldığı Profiller Profiles	İmalat Ölçüleri Dimensions	Aksesuar Accessories
125	Menteşe (dışa açılır) Hinge (outward opening) 4 Adet Mentеше 4 Piece Hinges	M14	80ST14-80ST26 Her kapı için 2 adet 2 piece for door	-----	
126	Menteşe (dışa açılır) Vidalı Ankraj Hinge (outward opening) Screw Anchor 4 Adet Mentеше + 16 Vidalı Ankraj / Paket 4 Piece Hinges + 16 Screw Anchors / Pocket	M181	80ST11-80ST24-80ST43 Her kapı için 2 adet 2 piece for door	----	
127	Menteşe (dışa açılır) Hinge (outward opening) 4 Adet / Paket 4 Piece / Pocket	M18	80ST11-80ST24-80ST43 Her kapı için 2 adet 2 piece for door	----	
128	Menteşe Hinge 4 Adet / Paket 4 Piece / Pocket	40 D 22	80ST10-80ST21 80ST10-80ST25 80ST11-80ST21 Her pencere için 2 adet 2 piece for door		
129	Gizli Mentеше Blind Hinge 1 Takım / Paket 1 Kit / Pocket	43 - 358	80ST61 Her pencere için 1 takım 1 kit for window		
130	Menteşe Hinge 4 Adet / Paket 4 Piece / Pocket	40 D 27	80ST10-80ST21 80ST10-80ST25 80ST11-80ST21 Her kapı için 2 adet 2 piece for door		
131	Pivot Açılım Kanat MentешеTakım Hinge 2 Adet mentеше 2 Adet pivot bağlantı aparatı üst 2 Adet pivot bağlantı aparatı alt	TP9 001	80ST49 80ST26 80ST10		
132	Vidalı Ankraj Screw Anchor	ME-15	80ST13-80ST24 Her mentеше için 2 adet 2 piece for hinge		

ST 80



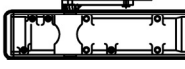
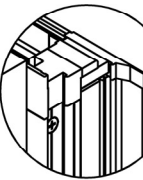
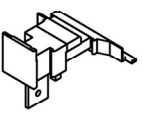

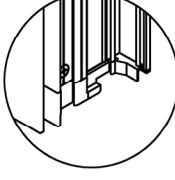
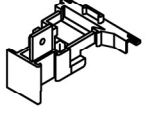
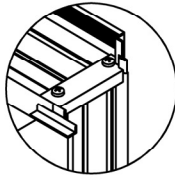
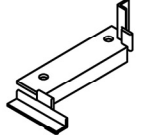
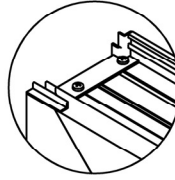
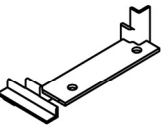
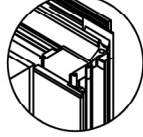
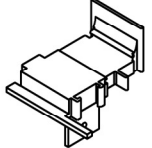
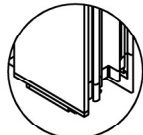
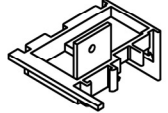
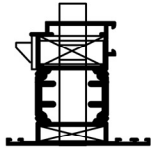
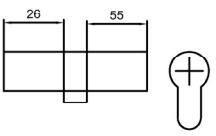
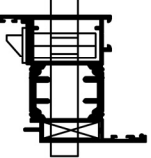
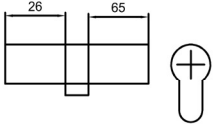
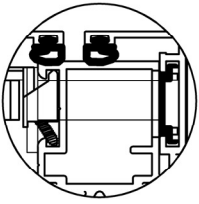

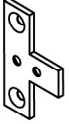

No	Aksesuar Adı Accessories Name	Kodu Code	Kullanıldığı Profiller Profiles	İmalat Ölçüleri Dimensions	Aksesuar Accessories
133	İspanyolet takımı (İçe açılır kapı) Espagnolette kit (Inward opening door) 5 adet karşılık, 4 adet pim, 1 adet kol karşılığı 2 adet ispanyolet çubuğu (100 cm)	M-72	1 takım / Paket 1 kit / Pocket		
134	İspanyolet takımı (İçe açılır pencere max.1400 mm) Espagnolette kit (Inward opening window) 3 adet karşılık, 2 adet pim, 1 adet kol karşılığı 2 adet ispanyolet çubuğu (50 cm)	M-71	1 takım / Paket 1 kit / Pocket		
135	Çıta Sabiti Glazing Clamp 10 Adet / Paket 10 Piece / Pocket	36-944	80ST21-80ST22 80ST23-80ST24 80ST25-80ST26 80ST27-80ST28 80ST29 Her 30 cm 'de 1 adet 1 piece for 30 cm		
136	Vasistas Makas (25 cm) Friction Hinge (25 cm)	M09 004	80ST10-80ST21 80ST10-80ST25 80ST11-80ST21 Her pencere için 2 adet 2 piece for window		
137	3 mm İç Cam Fıtılı 3 mm Inside Glazing Gasket 200 mt /Koli 200 mt / Package	40 D 03	80ST21-80ST24 80ST22-80ST25 80ST23-80ST61		
138	5 mm İç Cam Fıtılı 5 mm Inside Glazing Gasket 150 mt /Koli 150 mt / Package	MN 201	80ST23-80ST24 80ST61		
139	4 mm İç Cam Fıtılı 4 mm Inside Glazing Gasket 200 mt /Koli 200 mt / Package	40 D 05	80ST21-80ST24 80ST22-80ST25 80ST23-80ST61		
140	EPDM Kasa Takoz Fıtılı EPDM Central Gasket 50 mt /Koli 50 mt / Package	ST 801	80ST10-80ST21 80ST11-80ST25 80ST61		
141	İç Cam Fıtılı Inside Glazing Gasket 200 mt /Koli 200 mt / Package	HY18	80ST21-80ST24 80ST22-80ST25 80ST23-80ST61		
142	EPDM İç/Dış Bini Fıtılı EPDM Internal/External Gasket 500 mt /Koli 500 mt / Package	ST 610	80ST11-80ST23 80ST12-80ST13 80ST24		
143	EPDM İç Bini Fıtılı EPDM Internal Gasket 350 mt /Koli 350 mt / Package	F04 003	80ST10-80ST21 80ST11-80ST25 80ST61		

ST 80

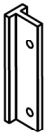
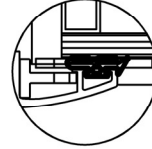
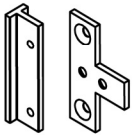
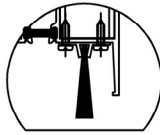

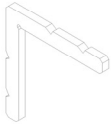
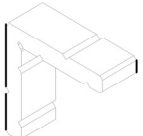

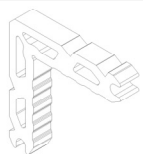
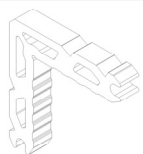
No	Aksesuar Adı Accessory Name	Kodu Code	Kullanıldığı Profiller Profiles	İmalat Ölçüleri Dimensions	Aksesuar Accessories
144	3 mm Dış Cam Fiteli 3 mm Outside Glazing Gasket	40 D 02	80ST21 80ST24 80ST22 80ST25 80ST23 80ST61		
145	EPDM Dış Bini Fiteli EPDM External Gasket	40 D 08	80ST10-80ST21 80ST11-80ST25 80ST61		
153	4 mm Dış Cam Fiteli 4 mm Outside Glazing Gasket	ST-802	80ST17 - 80ST31 80ST26 - 80ST27		
154	EPDM Dış Bini Fiteli EPDM External Gasket	F09 018	80ST62 80ST75		
155	Adaptör Fiteli Adapter gasket	F09 020	80ST33 60ST58		
156	Interax Kapı Pompası Door Closer	DC 250	Her kapı için 1 adet 1 piece for door	Maksimum kapı ağırlığı: 120 kg Maksimum kapı kanat genişliği: 1400 mm	
157	Interax Kapı Pompası Door Closer	DC 330	- Her kapı için 1 adet 1 piece for door	Maksimum kapı ağırlığı: 80 kg Maksimum kapı kanat genişliği: 1100 mm	
158	Interax Kapı Pompası Door Closer	DC 240	- Her kapı için 1 adet 1 piece for door	Maksimum kapı ağırlığı: 120 kg Maksimum kapı kanat genişliği: 1400 mm	
159	Interax Kapı Pompası Door Closer	DC 335	- Her kapı için 1 adet 1 piece for door	Maksimum kapı ağırlığı: 100 kg Maksimum kapı kanat genişliği: 1250 mm	
160	Pencere Adaptör Üst Plastiği Plastic Sealing Element	AP 81	80ST40 Her adaptör profil için 1 adet 1 piece for adapter profile		

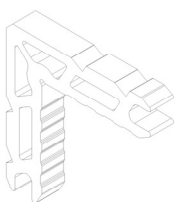

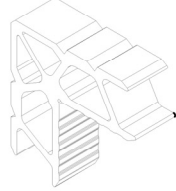
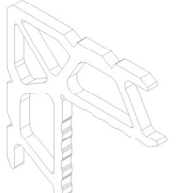
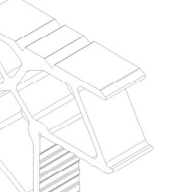

No	Aksesuar Adı Accessory Name	Kodu Code	Kullanıldığı Profiller Profiles	İmalat Ölçüleri Dimensions	Aksesuar Accessories
161	Pencere Adaptör Alt Plastiği Plastic Sealing Element	AP 82	80ST40 Her adaptör profil için 1 adet 1 piece for adapter profile		
162	Kapı Adaptör Plastiği (Sağ) Plastic Sealing Element	AP 83	80ST23-80ST24 Her adaptör profil için 1 adet 1 piece for adapter profile		
163	Kapı Adaptör Plastiği (Sol) Plastic Sealing Element	AP 84	80ST23-80ST24 Her adaptör profil için 1 adet 1 piece for adapter profile		
164	Adaptör Plastiği (Üst) Plastic Sealing Element	AP 85	80ST26-80ST31		
165	Adaptör Plastiği (Üst) Plastic Sealing Element	AP 86	80ST26-80ST31		
166	Barel Cylinder	B01 005	80ST24 Her kapı için 1 adet 1 piece for door		
167	Barel Cylinder	B 01 006	80ST23 80ST26 Her kapı için 1 adet 1 piece for door		
168	Çift Kanat Sürgü Mekanizması	043-017	80ST25 80ST40		
169	Sürgü Add-on flush bolt	40 D 53	-----	-----	

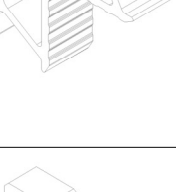
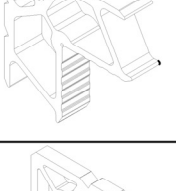
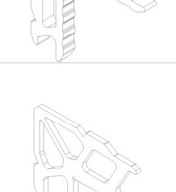
ST 80



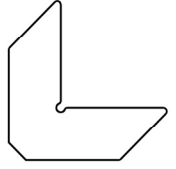
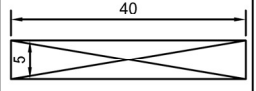
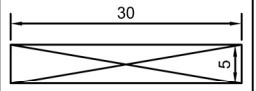
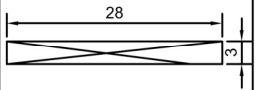

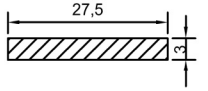
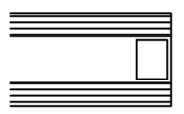
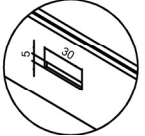







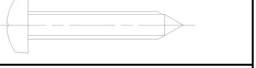
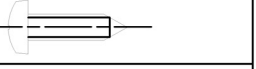
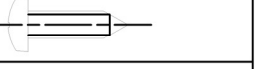
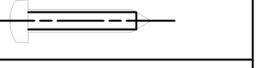
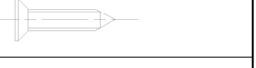

No	Aksesuar Adı Accessories Name	Kodu Code	Kullanıldığı Profiller Profiles	İmalat Ölçüleri Dimensions for Assembling	Aksesuar Accessories
170	Kayıt Bağlantı Parçası-erkek T Celat -male	36 940	80 ST 17 Her profil için 1 adet 1 piece for profile		
171	Kayıt Bağlantı Parçası-dişi T Cleat - female	36 941	80 ST 17 Her profil için 1 adet 1 piece for profile		
172	Kayıt Bağlantı Parçası Takımı T Cleat Kit	36 942	80 ST 17 Her kayıt için 2 takım 2 kit for transom		
173	Kapı Altı Fırçası Brush Weather Strip	361-52	80ST33		
174	Köşe Takoza Corner Cleat	X1 93 05	80ST25	
175	Köşe Takoza Corner Cleat	X1 96 26	80ST10 80ST30	
176	Köşe Takoza Corner Cleat	X1 82 05	80ST61	
180	Köşe Takoza Corner Cleat	X1 91 10	80ST10	
181	Köşe Takoza Corner Cleat	X1 91 20	80ST43	
182	Köşe Takoza Corner Cleat	X1 89 10	80ST21	
184	Köşe Takoza Corner Cleat	X1 89 32	80ST25	

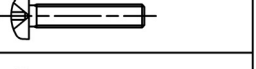
ST 80

No	Aksesuar Adı Accessories Name	Kodu Code	Kullanıldığı Profiller Profiles	İmalat Ölçüleri Dimensions for Assembling	Aksesuar Accessories
185	Köşe Takoza Corner Cleat	X1 92 10	80ST11	
186	Köşe Takoza Corner Cleat	X1 92 26	80ST11 80ST31 80ST32	
187	Köşe Takoza Corner Cleat	X1 98 10	80ST13	
188	Köşe Takoza Corner Cleat	X1 98 27	80ST21	
189	Köşe Takoza Corner Cleat	X1 88 27	80ST22	-----	
190	Köşe Takoza Corner Cleat	X1 94 10	80ST12 80ST22 80ST23	
191	Köşe Takoza Corner Cleat	X1 94 20	80ST12	
192	Köşe Takoza Corner Cleat	X1 94 26	80ST13	-----	
193	Köşe Takoza Corner Cleat	X1 94 27	80ST14	
194	Köşe Takoza Corner Cleat	X1 94 28	80ST61	
195	Köşe Takoza Corner Cleat	X1 87 10	80ST24 80ST26	
196	Köşe Takoza Corner Cleat	X1 87 20	80ST23 80ST24	-----	
197	Köşe Takoza Corner Cleat	X1 87 27	80ST26	
198	Köşe Takoza Corner Cleat	X1 97 07	80ST43	-----	
199	Köşe Takoza Corner Cleat	X1 84 03	80ST14	
200	Köşe Takoza Corner Cleat	X1 84 06	80ST62	-----	
201	Köşe Takoza Corner Cleat	X1 84 26	80ST49	

No	Aksesuar Adı Accessories Name	Kodu Code	Kullanıldığı Profiller Profiles	İmalat Ölçüleri Dimensions for Assembling	Aksesuar Accessories
202	Köşe Gönyesi Mitre Joint Angle	M-30	80ST14	-----	
203	Köşe Gönyesi Mitre Joint Angle	40 D 21	80ST10 80ST49		
204	Köşe Gönyesi Mitre Joint Angle	361-937	80ST61		
207	Köşe Gönyesi Mitre Joint Angle	G01 007	80ST49		
210	5x40 mm Plastik Cam Takoza 5x40 mm Plastic Setting Block	C01 011	-----	-----	
211	5x30 mm Plastik Cam Takoza 5x30 mm Plastic Setting Block	C01 010	-----	-----	
212	3x28 mm Plastik Cam Takoza 3x28 mm Plastic Setting Block	C01 005	-----	-----	
213	Kör Kasa (69x27x3) Steel	-----	-----	-----	
214	Kör Kasa (63x25x3) Steel	-----	-----	-----	
215	Lama / Lama	01-1578	-----	-----	
216	Isı Cam Insulated Glass	-----	-----	-----	
217	Tahliye Delik Tapası Cover Cap	40 D 13	80ST10-80ST11 80ST12-80ST13 80ST61		

ST 80

No	Aksesuar Adı Accessories Name	Kodu Code	Kullanıldığı Profiller Profiles	İmalat Ölçüleri Dimensions for Assembling	Aksesuar Accessories
218	Taş Yünü Rock Wool	----	----	-----	
219	YSB Saç Vidası Socket Head Tapping Screw	V2 48 60	80ST10 80ST49	
220	YSB Saç Vidası Socket Head Tapping Screw	V2 48 50	80ST10 80ST49	
221	YSB Saç Vidası Socket Head Tapping Screw	V2 48 38	80ST45	
222	YSB Saç Vidası Socket Head Tapping Screw	V2 48 32	M11 001	
223	YSB Saç Vidası Socket Head Tapping Screw	V2 48 25	80ST45	
224	YSB Saç Vidası Socket Head Tapping Screw	V2 42 19	80ST22	
225	YSB Saç Vidası Socket Head Tapping Screw	V2 35 13	80ST22	
226	YSB Saç Vidası Socket Head Tapping Screw	V2 29 16	80ST22	
227	YHB Saç Vidası Countersink Tapping Screw	V1 29 16	80ST41 80ST11	
228	YHB Metrik Vida Countersink Regular Thread Screw	V5 60 20	80ST10	
229	YHB Metrik Vida Countersink Regular Thread Screw	V5 50 45	
230	YSB Metrik Vida Countersink Regular Thread Screw	V6 60 30	80ST26	
231	YSB Saç Vidası Socket Head Tapping Screw	V2 60 35	80ST15 80ST10	
232	YSB Saç Vidası Socket Head Tapping Screw	V2 60 30	80ST16	
233	YSB Saç Vidası Socket Head Tapping Screw	V2 35 38	80ST58	
234	Silikon WS-605 Silicone	D06 001	
235	Isı Yalıtım bantı Thermally Insulation Tape	M-55	
236	Yapışkanlı bant Sticky Tape	D04 015	
237	EPS Ekspanse Polistiren Strafor	----	-----	
238	Alüminyum Levha Aluminium Panel	----	-----	-----