

Camın yapacağı sehim ve limit değerler ayrıca kontrol edilmelidir.

Aşağıdaki diyagramlar genel uygulamalar için olup, diğer rüzgar yüklerindeki uygulamalarınız için lütfen temasa geçiniz.

Deflection of the glass and limit values of the profiles have to be checked separately

Following diagrams can be used for general applications, please don't hesitate to contact for other wind loads.

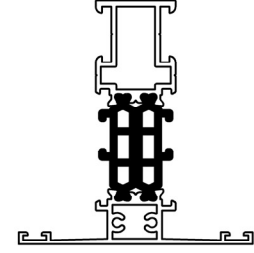
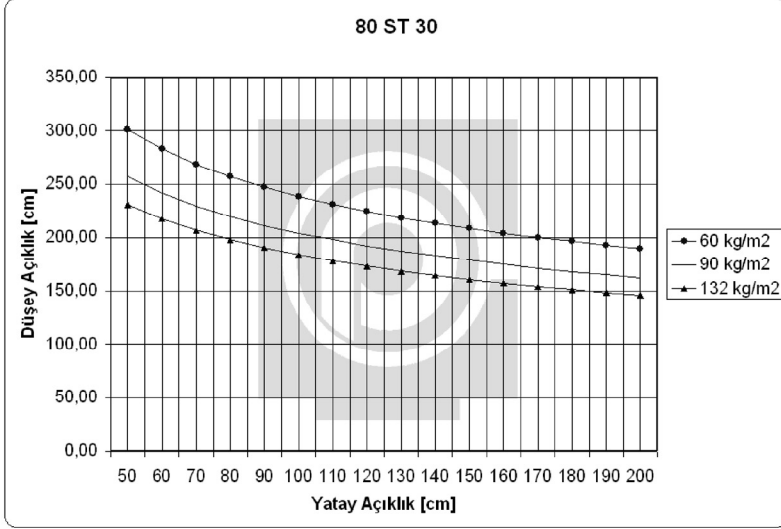

80 ST 30

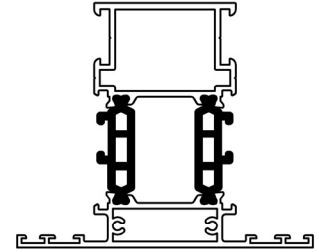
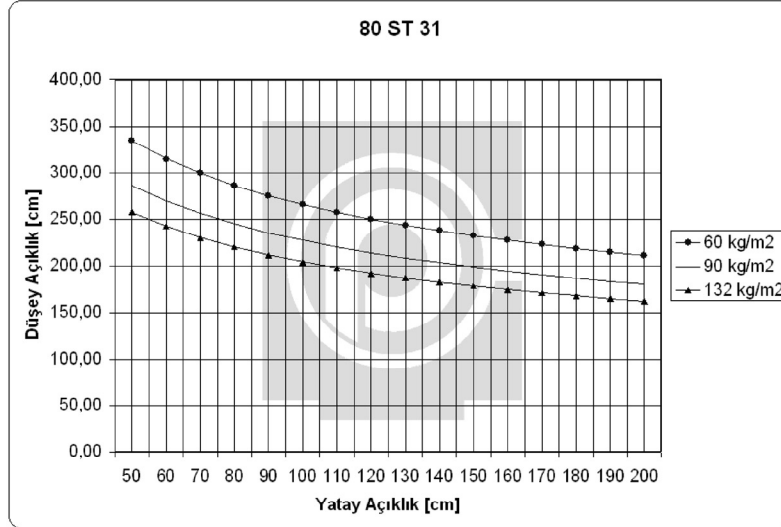

80 ST 31

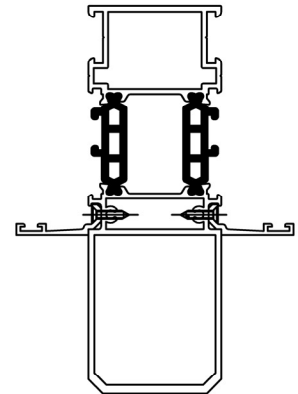
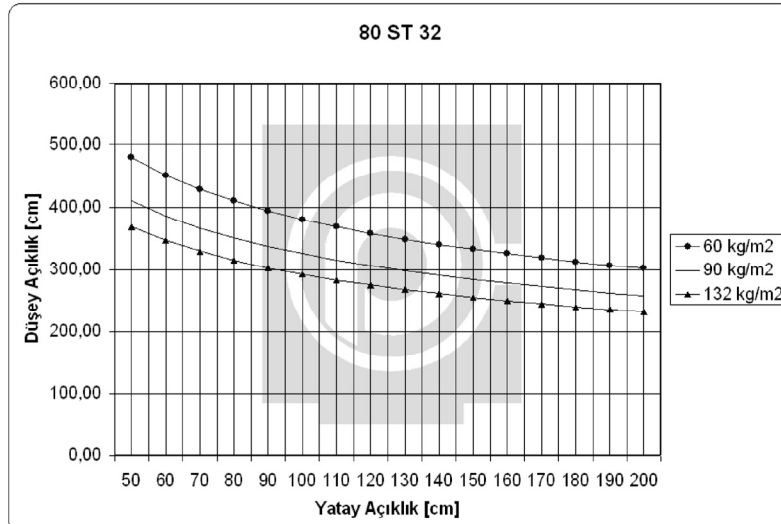

80 ST 32

ST 80

Statik Diyagramlar - Kanat Maksimum Ölçüleri
Camlama tipi ve takozlama ayrıca kontrol edilmelidir.
Aşağıdaki diyagram genel uygulamalar için olup, diğer
ebatlardaki uygulamalarınız için lütfen temasa geçiniz.

Static Diagrams - Maximum Vent Size
Glazing type and location of the setting block have to be
checked separately
Following diagram can be used for general applications,
please don't hesitate to contact for other dimensions

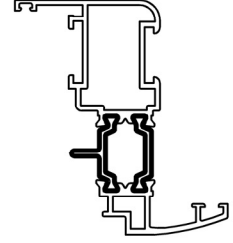
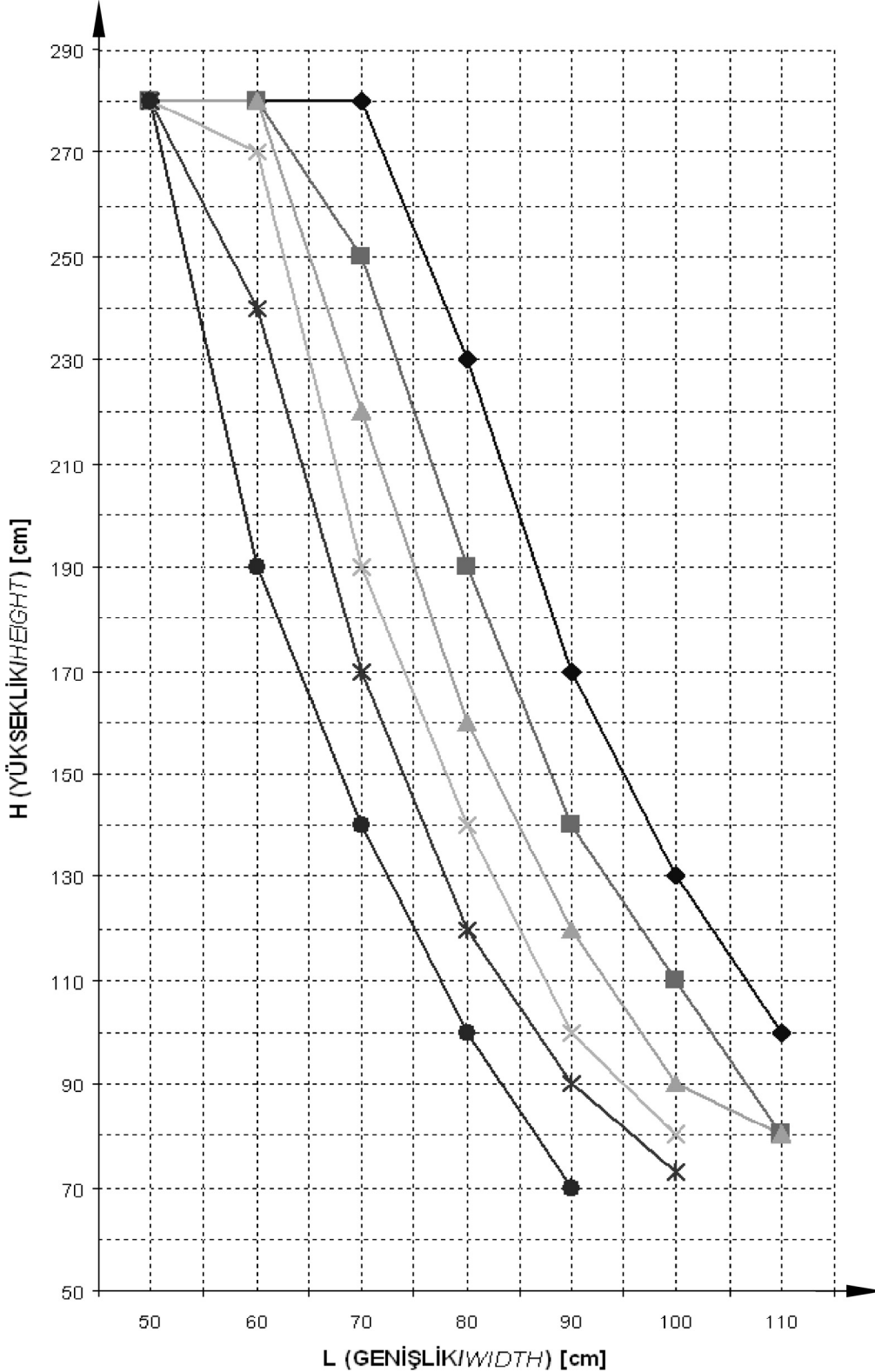

Kanat Profili / (Vent Profile)
80 ST 25

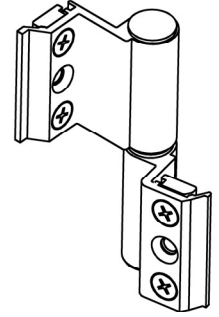

Menteşe (Hinge)
40 D 22
H < 2,1 m 2 adet (Piece)
H > 2,1 m 3 adet (Piece)
H > 2,5 m 4 adet (Piece)

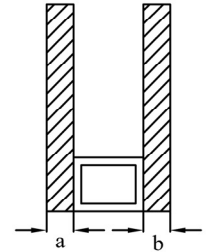

Cam Kalınlığı = a + b
(Glass Thickness = a + b)

- ◆ a+b = 8 mm
- a+b = 10 mm
- ▲ a+b = 12 mm
- × a+b = 14 mm
- * a+b = 16 mm
- a+b = 20 mm

ST 80

Statik Diyagramlar - Kanat Maksimum Ölçüleri
Camlama tipi ve takozlama ayrıca kontrol edilmelidir.
Aşağıdaki diyagram genel uygulamalar için olup, diğer
ebatlardaki uygulamalarınız için lütfen temasa geçiniz.

Static Diagrams - Maximum Vent Size
Glazing type and location of the setting block have to be
checked separately
Following diagram can be used for general applications,
please don't hesitate to contact for other dimensions

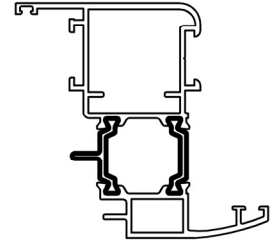
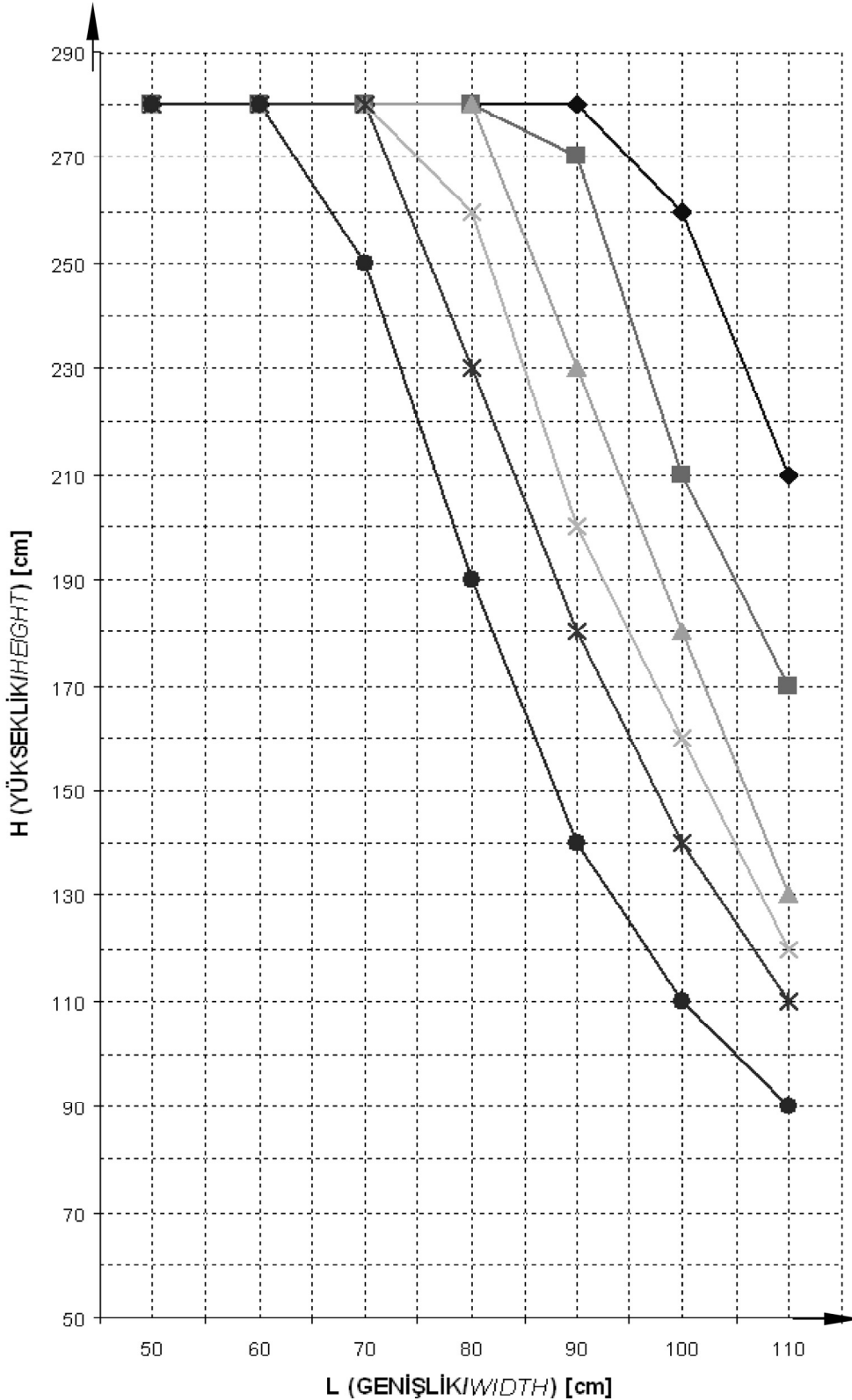

Kanat Profili / (Vent Profile)
80 ST 21

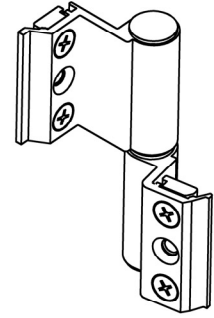

Menteşe (Hinge)
40 D 27
H < 2,1 m 2 adet (Piece)
H > 2,1 m 3 adet (Piece)
H > 2,5 m 4 adet (Piece)

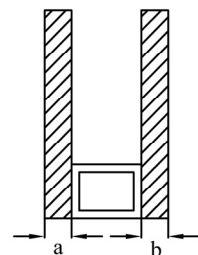

Cam Kalınlığı = a + b
(Glass Thickness = a + b)

- ◆ a+b = 8 mm
- a+b = 10 mm
- ▲ a+b = 12 mm
- ✖ a+b = 14 mm
- ✱ a+b = 16 mm
- a+b = 20 mm

ST 80

Statik Diyagramlar - Kanat Maksimum Ölçüleri
Camlama tipi ve takozlama ayrıca kontrol edilmelidir.
Aşağıdaki diyagram genel uygulamalar için olup, diğer ebatlardaki uygulamalarınız için lütfen temasa geçiniz.

Static Diagrams - Maximum Vent Size
Glazing type and location of the setting block have to be checked separately
Following diagram can be used for general applications, please don't hesitate to contact for other dimensions

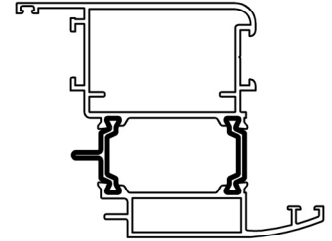
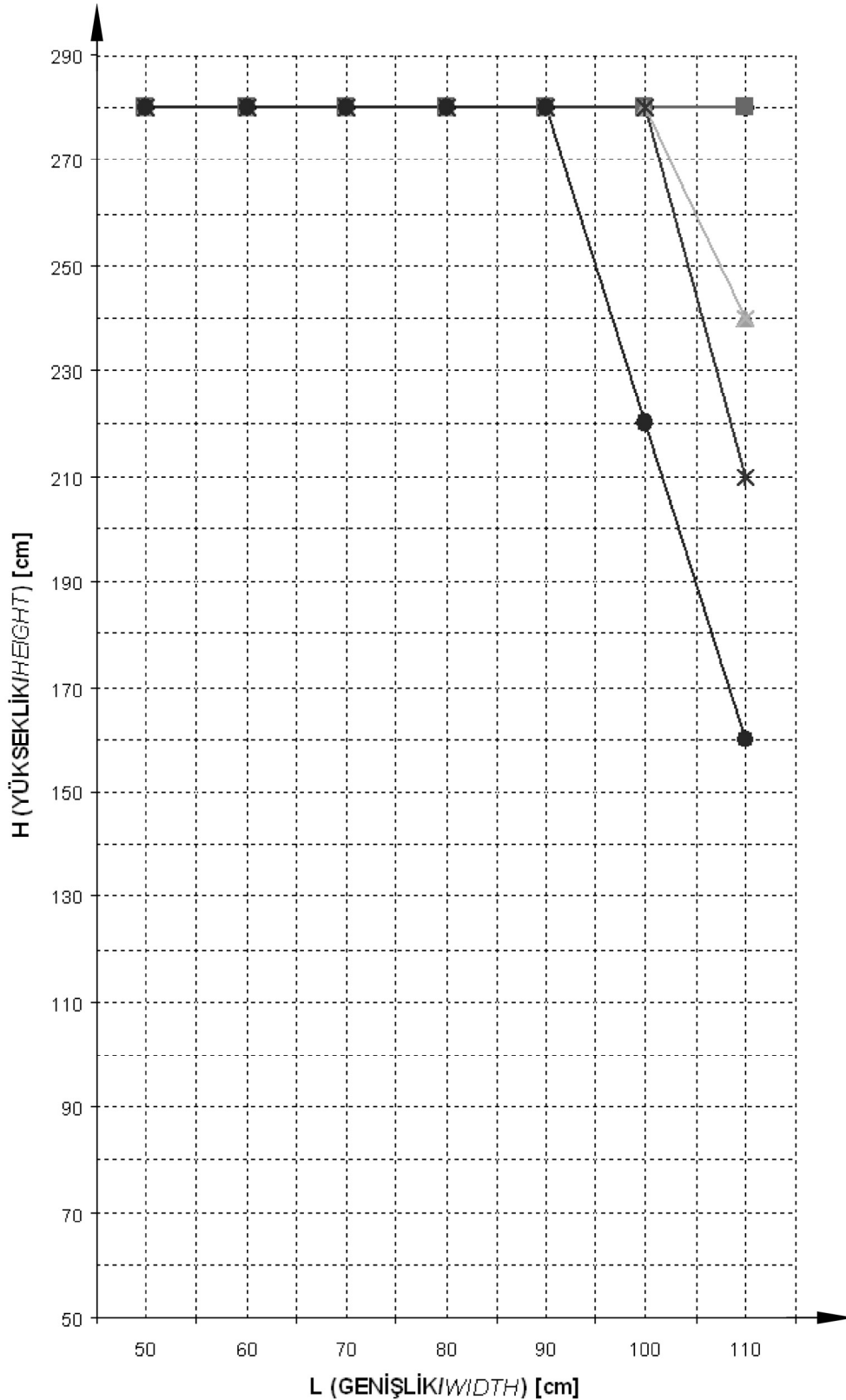

Kanat Profili / (Vent Profile)
80 ST 22

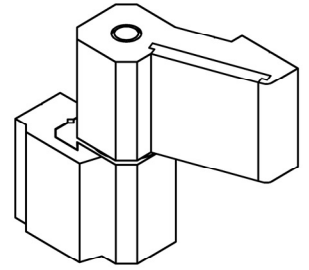

Menteşe (Hinge)

M10

H < 2,1 m 2 adet (Piece)

H > 2,1 m 3 adet (Piece)

H > 2,5 m 4 adet (Piece)

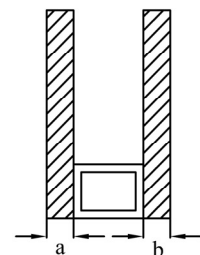

Cam Kalınlığı = a + b
(Glass Thickness = a + b)

- ◆ a+b = 8 mm
- a+b = 10 mm
- ▲ a+b = 12 mm
- ✖ a+b = 14 mm
- ✱ a+b = 16 mm
- ◆ a+b = 20 mm

ST 80

Statik Diyagramlar - Kanat Maksimum Ölçüleri
Camlama tipi ve takozlama ayrıca kontrol edilmelidir.
Aşağıdaki diyagram genel uygulamalar için olup, diğer
ebatlardaki uygulamalarınız için lütfen temasa geçiniz.

Static Diagrams - Maximum Vent Size
Glazing type and location of the setting block have to be
checked separately
Following diagram can be used for general applications,
please don't hesitate to contact for other dimensions

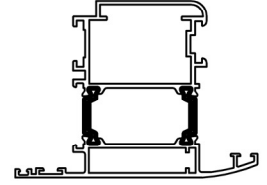
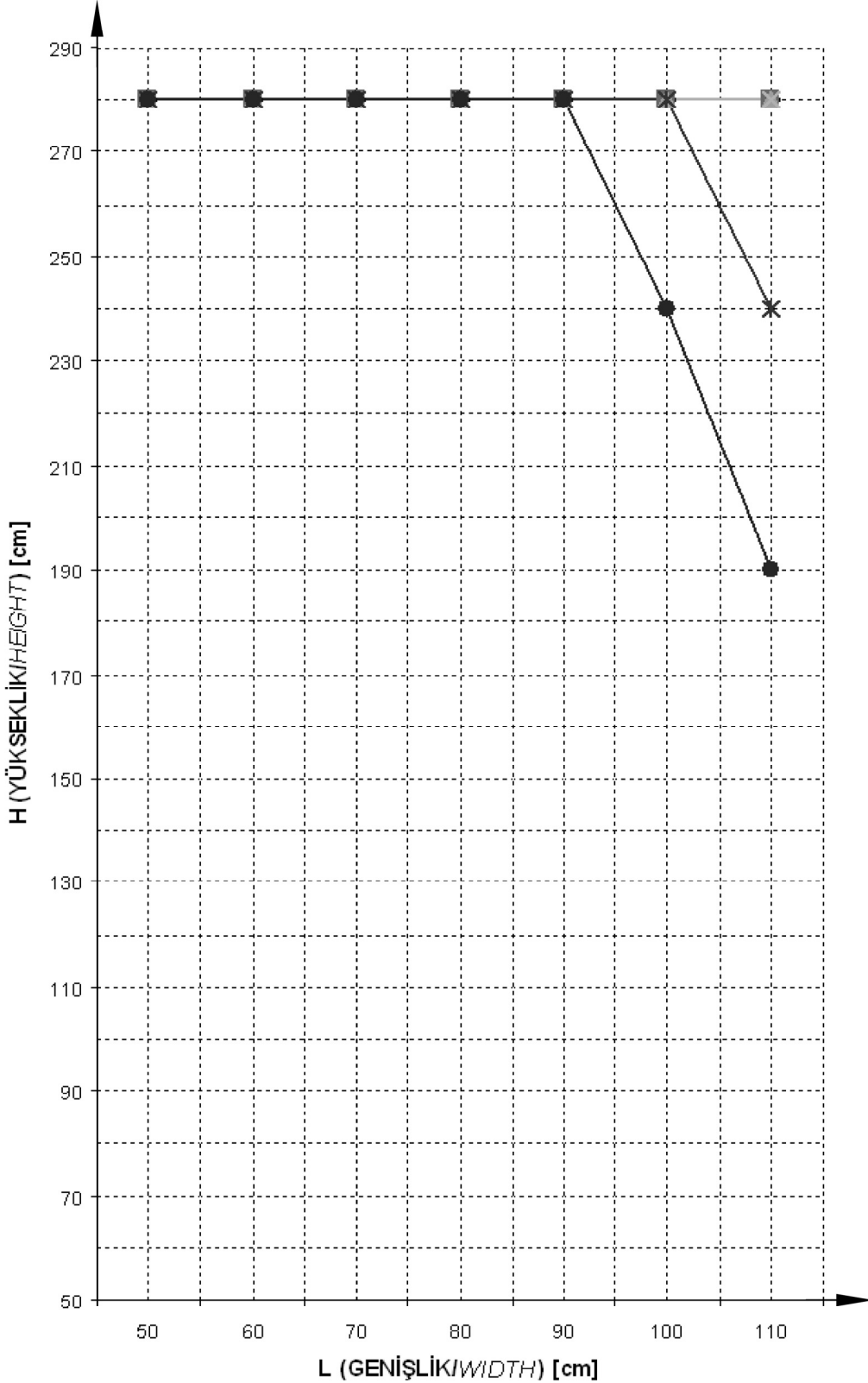

Kanat Profili / (Vent Profile)
80 ST 26

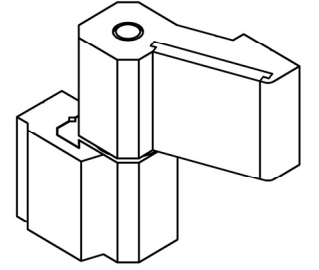

Menteşe (Hinge)
M10
H < 2,1 m 2 adet (Piece)
H > 2,1 m 3 adet (Piece)
H > 2,5 m 4 adet (Piece)

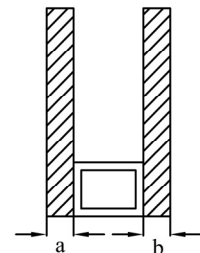

Cam Kalınlığı = a + b
(Glass Thickness = a + b)

- a+b = 8 mm
- a+b = 10 mm
- ▲ a+b = 12 mm
- × a+b = 14 mm
- * a+b = 16 mm
- a+b = 20 mm

ST 80

Statik Diyagramlar - Kanat Maksimum Ölçüleri
Camlama tipi ve takozlama ayrıca kontrol edilmelidir.
Aşağıdaki diyagram genel uygulamalar için olup, diğer
ebatlardaki uygulamalarınız için lütfen temasa geçiniz.

Static Diagrams - Maximum Vent Size
Glazing type and location of the setting block have to be
checked separately
Following diagram can be used for general applications,
please don't hesitate to contact for other dimensions

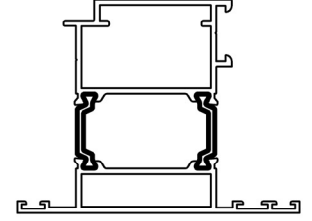
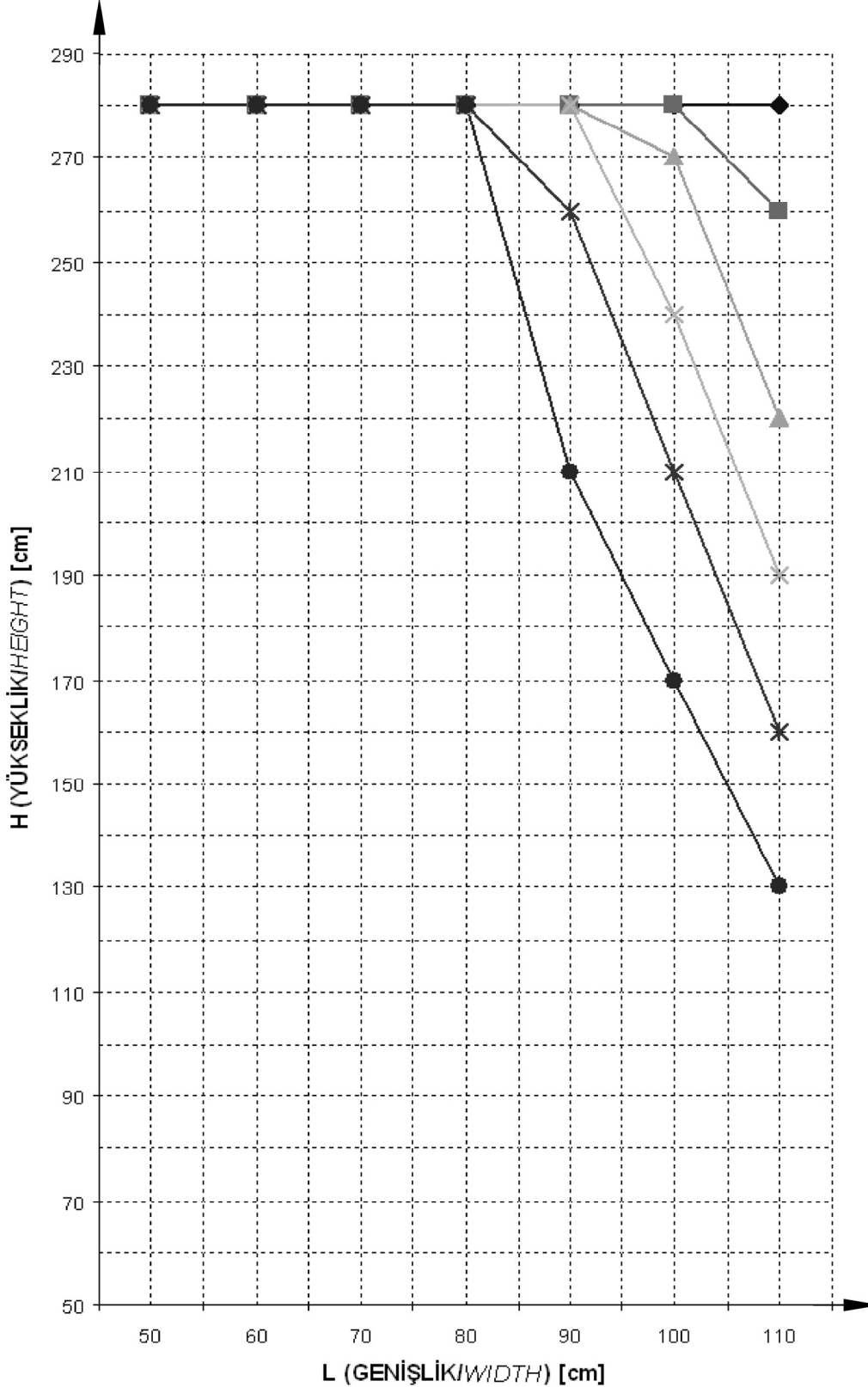

Kanat Profili / (Vent Profile)
80 ST 24

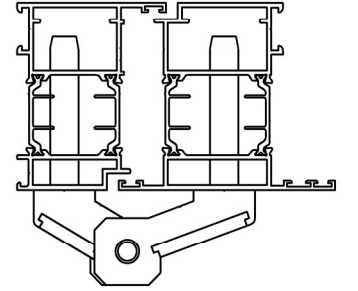

Menteşe (Hinge)
M12
H<2,1 m 2 adet (Piece)
H>2,1 m 3 adet (Piece)
H>2,5 m 4 adet (Piece)

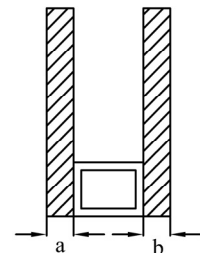

Cam Kalınlığı = a + b
(Glass Thickness = a + b)

- ◆ a+b = 8 mm
- a+b = 10 mm
- ▲ a+b = 12 mm
- × a+b = 14 mm
- * a+b = 16 mm
- a+b = 20 mm

ST 80

Statik Diyagramlar - Kanat Maksimum Ölçüleri
Camlama tipi ve takozlama ayrıca kontrol edilmelidir.
Aşağıdaki diyagram genel uygulamalar için olup, diğer
ebatlardaki uygulamalarınız için lütfen temasa geçiniz.

Static Diagrams - Maximum Vent Size
Glazing type and location of the setting block have to be
checked separately
Following diagram can be used for general applications,
please don't hesitate to contact for other dimensions

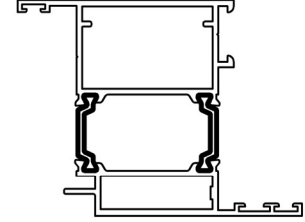
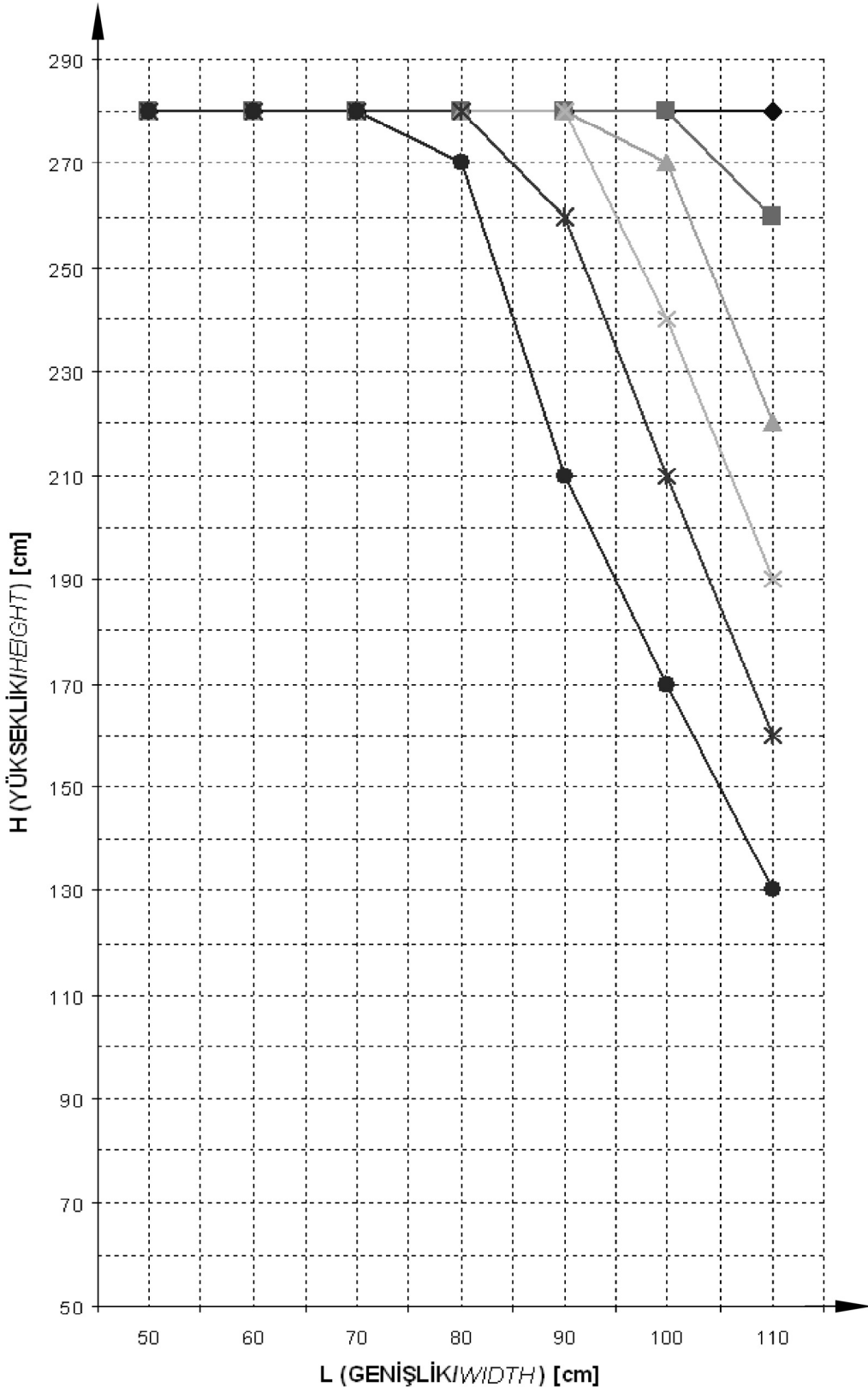

Kanat Profili / (Vent Profile)
80 ST 23

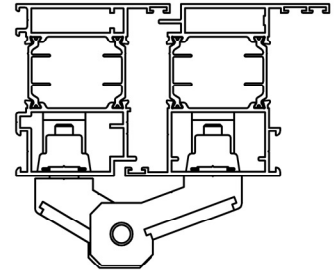

Menteşe (Hinge)

M12

H < 2,1 m 2 adet (Piece)

H > 2,1 m 3 adet (Piece)

H > 2,5 m 4 adet (Piece)

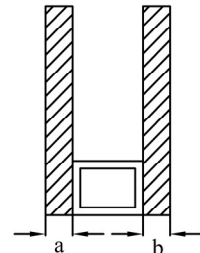

Cam Kalınlığı = a + b
(Glass Thickness = a + b)

- ◆ a+b = 8 mm
- a+b = 10 mm
- ▲ a+b = 12 mm
- × a+b = 14 mm
- * a+b = 16 mm
- a+b = 20 mm

ST 80

Statik Diyagramlar - Kanat Maksimum Ölçüleri
Camlama tipi, takozlama ve aksesuar kapasitesi ayrıca kontrol edilmelidir. Aşağıdaki diyagram genel uygulamalar için olup, diğer ebatlardaki uygulamalarınız için lütfen temasa geçiniz.

Static Diagrams - Maximum Vent Size
Glazing type, location of the setting block and carrying capacity of the accessories have to be checked separately
Following diagram can be used for general applications, please don't hesitate to contact for other dimensions

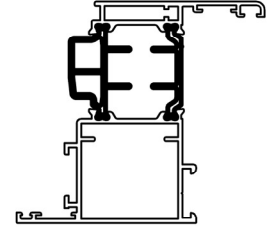
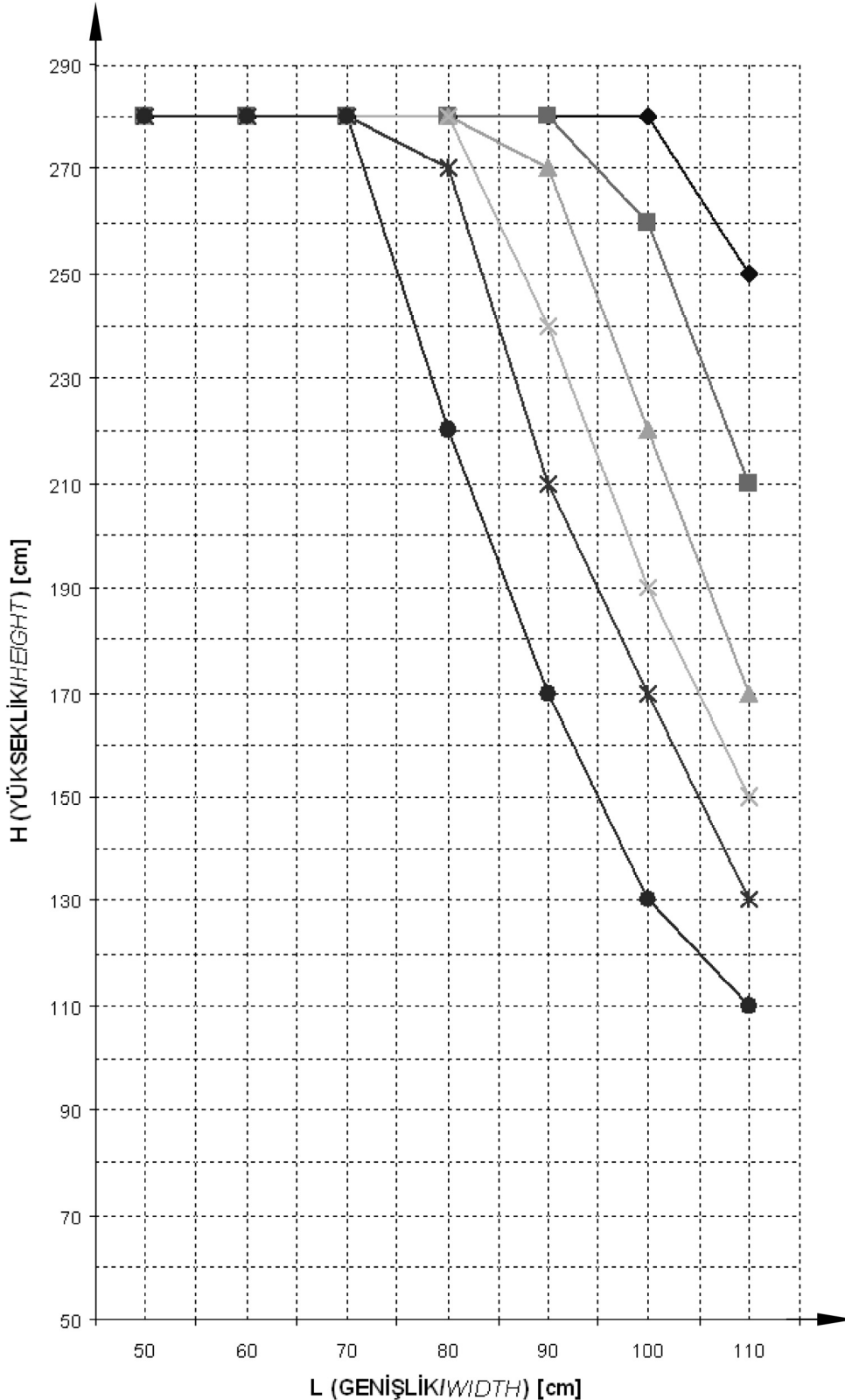

Kanat Profili / (Vent Profile)
80 ST 61

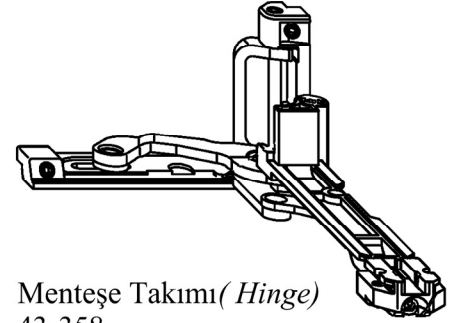

Menteşe Takımı (Hinge)
43-358

Kanat ağırlığı max 100 kg
Weight of the vent max 100 kg

Sağ 1 adet (1 Piece for right)
Sol 1 adet (1 Piece for left)

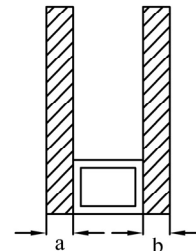

Cam Kalınlığı = a + b
(Glass Thickness = a + b)

- ◆ a+b = 8 mm
- a+b = 10 mm
- ▲ a+b = 12 mm
- ✖ a+b = 14 mm
- ✱ a+b = 16 mm
- a+b = 20 mm

Evidence of Performance

Resistance to wind load
Watertightness
Air permeability
Operating forces, Mechanical properties
Load-bearing capacity of safety devices

Test Report 102 33372/3e (ITT)

Client **Cuhadaroglu**
metal sanayi ve pazarlama a.s.
Yakuplu Köyü Yolu

34900 B.Cekmece Istanbul
Turkey



Basis

EN 14351-1 : 2006-03, Win-
dows and external doors –
Product standard
Test standards men:
EN 1026 : 2000-06
EN 1027 : 2000-06
EN 12211 : 2000-06
EN 12046-1 : 2003-11
EN 14608 : 2004-03
EN 14609 : 2004-03

Representation



Instruction for use

The present test report serves to demonstrate the above characteristics of windows according to EN 14351-1 : 2006-03; For the purpose of certification it can be used as basis for the manufacturer ITT report summary for attestation of conformity procedure 3 as the basis for the manufacturer declaration.

Validity

The data and results refer solely to the tested and described specimen.

Subject to compliance with the relevant casement weights, the test results can be extrapolated for constructions of identical or smaller dimensions of the same design, type of rebate and similar format.

The test does not allow any statement to be made on further characteristics of the present structure and quality, in particular the effects of weathering and ageing.

Notes on publication

The ift-Guidance Sheet "Conditions and Guidance for the Use of ift test Documents" applies...

The cover sheet can be used as an abstract.

Contents

The report contains a total of 22 pages

Product	Single tilt and turn window with fixed toplight and sidelight
Designation	ST 80
Overall dimensions (W x H)	2200 mm x 2200 mm
Frame material	Thermal break aluminium profiles
Special features	-/-

Resistance to wind load – EN 12210



Class C2 / B2

Watertightness – EN 12208



Class 9A

Air permeability – EN 12207



Class 4

Operating forces – EN 13115



Class 1

Mechanical properties – EN 13115



Class 4

Load-bearing capacity of safety devices



Requirement fulfilled

ift Rosenheim
6. November 2007

Jörn Peter Lass, Dipl.-Ing. (FH)
Head of Testing Department
ift Centre Windows & Facades

Robert Kolacny, Dipl.-Ing. (FH)
Test engineer
ift Centre Windows & Facades



ift Rosenheim GmbH
Geschäftsführer:
Dipl.-Ing. (FH) Ulrich Seiberath
Dr. Jochen Peitzl

Theodor-Gießl-Str. 7-9
D-83026 Rosenheim
Tel.: +49 (0)80310291-0
Fax: +49 (0)80310291-390
www.ift-rosenheim.de

Str. 63026 Rosenheim
AG Traunstein, HRB 14763
Sparkasse Rosenheim
Kto. 3822
BLZ 711 600 00

Notified Body Nr.: 0757
Anerkannte PUZ-Stelle: BAY 18
